

STRUCTURAL ENGINEERING

M.E.P. ENGINEERING

CIVIL ENGINEERING

ASE ENGINEERING SERVICES, INC.  
STRUCTURAL DESIGN GROUP

10244 East Colonial Drive, Suite 202  
Orlando, Florida 32817 - (407) 477-5868 Fax (407) 730-2999  
Certificate of Authorization No. 25873

Mansheng Xie P.E.  
Florida No. 51161

STOFFER & ASSOCIATES INC.  
CONSULTING ENGINEERS

10281 Hart Branch Circle  
Orlando, Florida 32832 - (407) 381-4555 FAX (407) 249-1520  
CA #206069

Randall D. Stoffer, P.E. # 37367

# KADMAR PLAZA

## ORLANDO , FLORIDA

FLORIDA ENGINEERING GROUP INC.  
CONSULTING ENGINEERS

5127 S. Orange Avenue, Suite 200  
Orlando, Florida 32809 - (407) 392-8324 FAX (407) 895-0325  
CERTIFICATE #EB-0006595

Sam J. Sabatelli, P.E. # 42075

### GENERAL NOTES:

TENANT IS REQUIRED TO MAKE A FIELD SURVEY OF THE EXISTING ELECTRICAL SERVICE AND IS RESPONSIBLE FOR MAKING ANY AND/OR ALL MODIFICATIONS REQUIRED TO ENSURE THAT THE TOTAL CONNECTION LOAD DOES NOT EXCEED THE ELECTRICAL SERVICE.

APPROVAL OF TENANT'S CONSTRUCTION DOCUMENTS AND SPECIFICATIONS BY THE LANDLORD DOES NOT RELEASE THE TENANT OR THE TENANT'S CONTRACTOR FROM COMPLYING WITH THE LEASE AGREEMENT AND ALL APPLICABLE BUILDING CODES AND GOVERNING REGULATIONS.

NOTHING IS PERMITTED TO BE ATTACHED TO, SUSPENDED FROM, OR PENETRATE THE ROOF DECK ABOVE. YOU ARE REQUIRED TO FRAME, BRACE, AND/OR SUSPEND, AS NEEDED, TO/FROM THE TOP CHORD OF JOISTS OR STRUCTURAL STEEL WHICH EXISTS ABOVE YOUR RESPECTIVE TENANT SPACE.

THE TENANT SHALL BE RESPONSIBLE FOR VERIFYING THAT THESE REMODEL CONSTRUCTION DOCUMENTS MEET ALL A.D.A. STANDARDS OR REQUIREMENTS.

PLEASE NOTE: ANY ITEM SCHEDULED TO BE REUSED MUST BE REFURBISHED AND MAINTAINED TO A "LIKE NEW" CONDITION. NO EXCEPTIONS.

- ALL WORK SHALL CONFORM TO THE FOLLOWING: FLORIDA BUILDING CODE SIXTH EDITION (2011); BUILDING FLORIDA BUILDING CODE SIXTH EDITION (2011); FUEL GAS FLORIDA BUILDING CODE SIXTH EDITION (2011); MECHANICAL FLORIDA BUILDING CODE SIXTH EDITION (2011); PLUMBING 2011 FLORIDA FIRE PREVENTION CODE 2014 NATIONAL ELECTRIC CODE FLORIDA BUILDING CODE SIXTH EDITION (2011); ACCESSIBILITY CODE FLORIDA BUILDING CODE SIXTH EDITION (2011); ENERGY CONSERVATION
- SUBCONTRACTORS SHALL VERIFY ALL CONDITIONS, DETAILS AND DIMENSIONS BEFORE PROCEEDING WITH THE WORK AND SHALL BE NOTIFIED OF ANY DISCREPANCIES.
- DO NOT SCALE DRAWINGS.
- ALL WORK IN QUESTION INCLUDING MATERIALS, FINISHES AND COLORS SHALL BE COORDINATED WITH THE PROJECT MANAGER.
- SPRINKLER CONTRACTOR SHALL VERIFY EXISTING LAYOUT AND SUBMIT PROPOSAL OF WORK REQUIRED TO MEET CODE.
- MECHANICAL AND ELECTRICAL SUBCONTRACTORS SHALL BE RESPONSIBLE FOR SUBMITTING DRAWINGS AND OBTAINING THEIR RESPECTIVE PERMITS.
- TENANT TO CERTIFY THAT NO ASBESTOS CONTAINING MATERIAL HAS BEEN USED FOR CONSTRUCTION OF THIS PREMISES.
- ALL INTERIOR WALL AND CEILING FINISHES SHALL COMPLY WITH NFPA 101, SECTION 10.2.3 AND TABLE 803.5 OF FBC 2010.

OCCUPANCY - M (MERCANTILE), SHELL ONLY  
CONSTRUCTION TYPE - II-B, FULLY SPRINKLERED  
MIN. INT. FINISH CLASS - 'B'

FBC SIXTH EDITION (2011) - TABLE 601 - FIRE RESISTANCE RATING REQUIREMENTS FOR BUILDING ELEMENTS	
CONSTRUCTION TYPE II-B	
PRIMARY STRUCTURAL FRAME	0HR
BEARING WALLS	
EXTERIOR	0HR
INTERIOR	0HR
NONBEARING WALLS AND PARTITIONS	0HR
FLOOR CONSTRUCTION	0HR
ROOF CONSTRUCTION	0HR

NOTE:  
NEW DOORS AND WINDOWS HAVE BEEN DESIGNED TO MEET OR EXCEED THE REQUIREMENTS OF SEC. 1609 OF THE FLORIDA BUILDING CODE SIXTH EDITION (2011).

- RISK CATEGORY = II
- NOMINAL DESIGN WIND SPEED = 124
- ULTIMATE DESIGN WIND SPEED = 160
- WIND IMPORTANCE FACTOR = 1.0
- WIND EXPOSURE = CATEGORY 'C'

TABULAR INFORMATION	
CONDITIONED AREA	14,348 SQ FT
COVERED ENTRANCE	1,926 SQ FT
SPRINKLER ROOM	24 SQ FT
TOTAL AREA UNDER ROOF	16,898 SQ FT

INDEX OF DRAWINGS			
SHEET #	SHEET DESCRIPTION	REVISION	
ARCHITECTURAL	CS	COVER SHEET	
	GN01	GENERAL NOTES	
	GN02	GENERAL NOTES	
	GN03	GENERAL NOTES	
	GN04	GENERAL NOTES	
	GN05	GENERAL NOTES	
	GN06	GENERAL NOTES	
GN07	GENERAL NOTES		
STRUCTURAL	A100	SITE PLAN	
	A101	FLOOR PLAN	
	A102	REFLECTED CEILING PLAN	
	A103	ROOF PLAN	
	A201	EXTERIOR ELEVATIONS	
	A301	SECTIONS	
	A302	SECTION/ DETAILS	
	A601	SCHEDULES/ DETAIL	
	A701	LIFE SAFETY PLAN	
MECHANICAL	S1.01	STRUCTURAL GENERAL NOTES	
	S2.01	FOUNDATION PLAN	
	S3.01	ROOF FRAMING PLAN	
	S5.01	DETAILS	
	S5.02	DETAILS	
	S5.03	DETAILS	
	S5.04	DETAILS	
	S5.05	DETAILS	
ELECTRICAL	M-1	FLOOR PLAN - HVAC	
	M-2	HVAC NOTES AND DETAIL	
ELECTRICAL	ES1	SITE PLAN - ELECTRICAL	
	E-1	FLOOR PLAN - ELECTRICAL	
	E-2	ELECTRICAL DETAILS AND RISER	
PLUMBING	P-1	FLOOR PLAN - PLUMBING	
	P-2	PLUMBING ISOMETRICS	
	P-3	DETAILS & NOTES	

SHELL PERMIT ONLY - INTERIOR BUILDOUT WILL BE PERMITTED SEPARATELY AT A LATER DATE

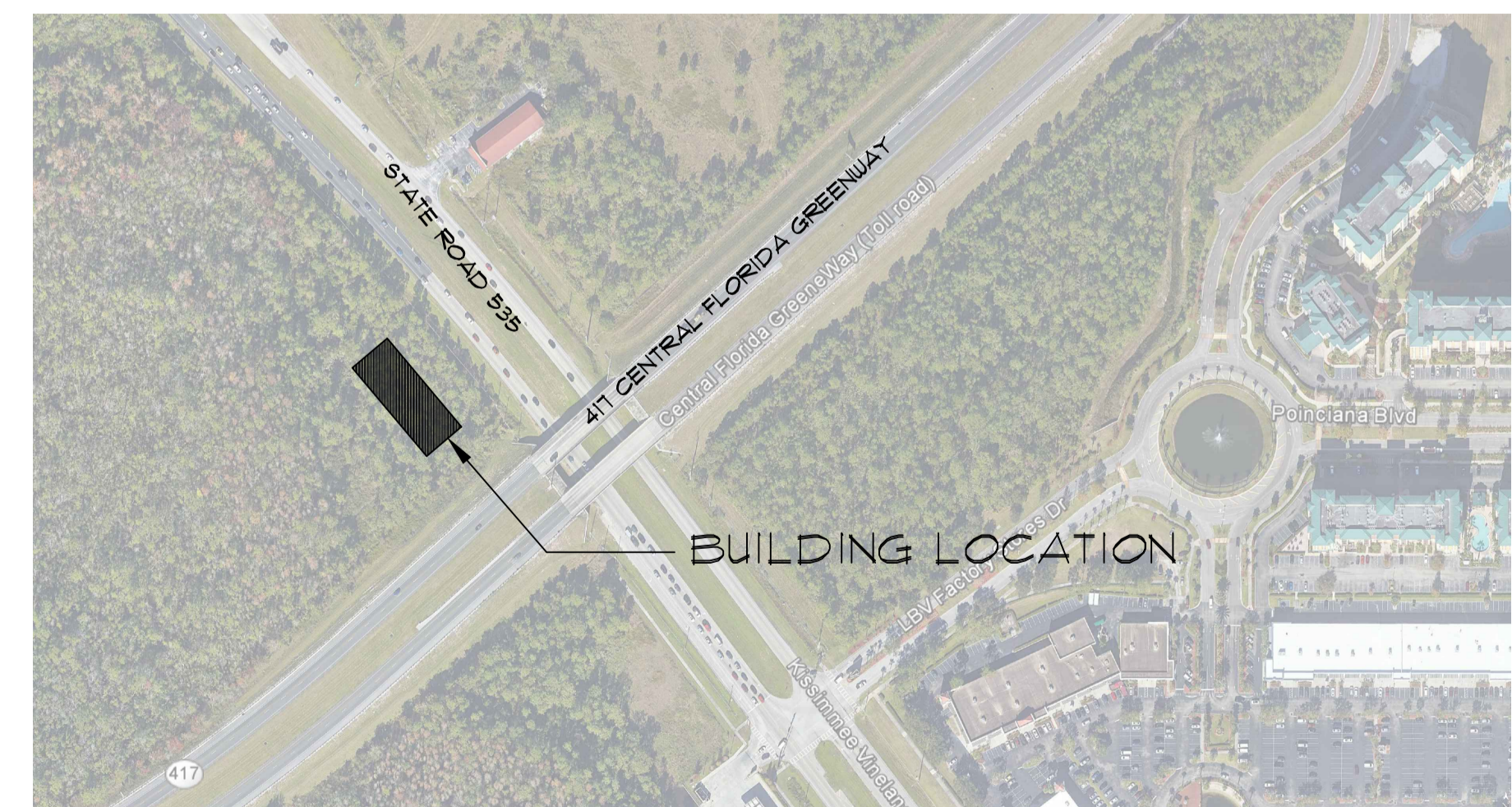

LOCATION PLAN

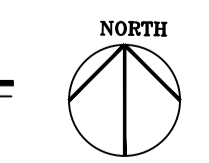

REVISIONS	PROJECT NO.	DATE
1	173098025-01	07/09/2018
2		
3		
4		
5		
6		
7		
8		

COVER SHEET

NEW RETAIL CENTER FOR:  
**KADMAR PLAZA**  
ORLANDO, FLORIDA

AA26002490  
RABITS & ROMANO ARCHITECTURE  
PLANNING AND DESIGN  
info@rabits-architect.com  
www.rabits-architect.com  
TEL - 407-996-0350  
FAX - 407-232-6000  
5127 SOUTH ORANGE AVE.  
SUITE 110 ORLANDO, FL 32809

SIGN/SEAL

DATE  
SHEET  
06  
OF  
33



2.2 WOOD-PRESERVATIVE-TREATED MATERIALS

- A. Preservative Treatment Process: AWPA C2 and AWPA C9...
1. Wood cuts, nails, clips, cement spots, and similar members in connection with roofing...
2. Wood studs, joists, bents, trusses, and similar concealed members in contact with masonry or concrete...
3. Wood framing members less than 18 inches above grade...
4. Wood floors that are installed over concrete slabs directly in contact with earth.

2.3 FIRE-RETARDANT TREATED MATERIALS

- A. General: Where fire-retardant-treated materials are indicated, provide materials that comply with performance requirements in AWPA C20 and AWPA C27...
1. Use treatment for which chemical manufacturer publishes physical properties of treated wood after effects to be evaluated...
2. Use treatment that does not promote corrosion of metal fasteners...
3. Use the letter code for letter indications and where indicated...
4. Use Interior or Exterior Temperature HT, unless otherwise indicated.

2.4 DIMENSION LUMBER

- A. General: Of grades indicated according to the American Lumber Standards Committee National Grading Rules...
1. Mill-dressed lumber...
2. Eastern softwoods: NELMA...
3. Sices and Grade: Hem-fir or Hem-fir (north); Select Structural Grade: NLGA, WCLL, or WWPA...
4. Sices and Grade: Spruce-Pine-Fir or Spruce-Pine-Fir (south); Select Structural: No. 1 Trade: NELMA, NLGA, WCLL, or WWPA.

2.5 SHEATHING

- A. Plywood Sheathing: Exterior, Structural Sheathing...
1. Manufacturer: American Gypsum Co., G-P Gypsum Corporation, National Gypsum Company, United States Gypsum Co...
2. Thickness: 1/2 inch and 5/8 inch...
3. Glass-Mat Gypsum Sheathing: ASTM C 1177...
4. Product Subject to compliance with requirements, provide "Dens-Glass Gypsum G-P Gypsum Corp"...
5. Manufacturer: DiversiFoam Products, Dow Chemical Company, Owens Corning, Tenneco Products...
6. Plywood Roof Sheathing: Exterior sheathing...
7. Oriented-Strand Board Roof Sheathing: Exterior sheathing.

2.6 PLYWOOD LACKING PANELS

- A. Type and Electrical Requirement: Panel DPC 1, E105, E1, C-D Plywood, fire-retardant treated, in thickness indicated or, if not indicated, not less than 1/2 inch thick.

2.7 MISCELLANEOUS MATERIALS

- A. Fasteners:
1. Where required, install in accordance with weather, in roof and contact, or in area of high relative humidity, provide fasteners with hot-dip zinc coating...
2. Power-Driven Fasteners: CA-0 NER-272...
3. Nails: See bolts comply with ASTM A 307, Grade A with ASTM A 563...
B. Adhesive:
1. CA-0 NER-272 for cover-drain fasteners...
2. Published requirements of metal framing anchor manufacturer...
D. Fasteners:
1. Use hot-dip galvanized or hot-dip galvanized steel fasteners to fasten to sheathing with galvanized nails or roofing nails...
2. Use sheathing nails to joints between sheathing panels and at items...
E. Adhesive:
1. Use adhesive to joints between sheathing panels and at items...
2. Use adhesive to joints between sheathing panels and at items...
3. Use adhesive to joints between sheathing panels and at items...

PART 3 - EXECUTION

3.1 INSULATION

- A. Set roof carrier to required grade and lines, with members in place, true to line, cut, and fitted. Fit roof carrier to other construction...
B. Adhesive treatment comply with AWPA M4 to all surfaces of preservative-treated lumber and plywood...
C. Securely attach roof carrier to substrate by anchoring and fastening as indicated, comply with the following:
1. CA-0 NER-272 for cover-drain fasteners...
2. Published requirements of metal framing anchor manufacturer...
D. Use hot-dip galvanized or hot-dip galvanized steel fasteners to fasten to sheathing with galvanized nails or roofing nails...
E. Use adhesive to joints between sheathing panels and at items...
F. Use adhesive to joints between sheathing panels and at items...

END OF SECTION 06100

SECTION 06200

PRE-ENGINEERED WOOD TRUSSES:

General: Provide pre-engineered wood trusses where shown. Comply with applicable requirements of NLMA's "National Design Specifications for Stress Graded Lumber and Its Fastenings" and Truss Plate Institute's "Light Metal Connected Wood Trusses". See notes regarding details and trade lumber for architect-fabricated areas.

Provide pre-engineered and shop-assembled trusses by a recognized manufacturer of wood trusses. Design for the span, loading, truss shape and section shown. If loads are not shown design as per governing design code. Fabricate in plant of manufacturer or his licensed fabricator.

Connector Plate Manufacturer Specifications: Provide truss connector plates manufacturer by a firm which is a member of TPI and which complies with TPI and AISC Control Deck for metal connector plates fabricated in TPI and AISC Standard for Metal Plate Connected Wood Trusses, and has a minimum of five years experience of similar projects.

Fabricator Specifications: Provide trusses by a firm which has a record of successful fabricating trusses similar to that indicated and which complies with the following requirements for fabricator:

Fabricator practices a quality control program which complies with, or is comparable to, one published in TPI and AISC Standard for Metal Plate Connected Wood Trusses and which includes inspection by an independent inspection and testing agency acceptable to Architect and authorities having jurisdiction.

Submit Test Results for Connector Plates: Provide metal connector plates from a manufacturer.

Quality Control: Submit Certification Fabricated Trusses have been inspected in accordance with TPI and AISC Control Deck for metal connector plates.

Store, handle, and erect trusses in accordance with manufacturer's printed instructions. Provide temporary bracing and bracing as required. Note: The truss erector shall design and provide temporary bracing and bracing as required during erection of the roof trusses, temporary bracing and bracing shall remain in place until the complete system has been installed and completed.

Installation: Unless otherwise shown, install continuous 2:4 horizontal bracing at top and bottom chord, at each end and at 8 feet on centers. Nail to each truss.

Submittals:

Manufacturer's specifications and installation instructions for pre-engineered wood trusses.

Show Drawings: Submit shop drawings for pre-engineered wood trusses. Provide erection plans, indicate stresses and stress grade of lumber to be used and details of metal connectors to be used at joints. Show field, span, and location of trusses, and all permanent bracing or diagonal bracing required. Provide air eave details of all connections and anchors.

Submit Truss Manufacturer's design and engineering data for pre-engineered wood trusses including stress diagrams and name and seal of a licensed professional structural engineer registered in Florida.

Submit truss manufacturer's specifications and quality control program procedures.

Performance Criteria and Design Requirements for Wood Trusses:

Wood trusses shall be designed in accordance with the design code specified and as indicated on the drawings. Wind loads shall be designed in accordance with the specified design requirements and the design code indicated. Wood truss submittals will not be reviewed or approved until the design requirements have been completed and a submittal has been received. Changes or revisions to the design criteria or intent of the drawings will not be approved unless approved in writing by the engineer prior to the shop drawings and truss engineering submittals.

The Design Code shall be The Florida Design Code, 2001 Edition, unless otherwise indicated. Wind design shall be based on ASCE 7-98. See drawing for additional wind design criteria.

All wood truss members shall be No. 2 Southern Pine or better minimum lumber grade for all top and bottom chords and all web members. Provide members of sufficient size and section for correct and slow installation of the support connectors shown on the drawings.

END OF SECTION 06200

SECTION 07110 - BUILDING INSULATION

PART 1 - GENERAL

1.1 SUMMARY

- A. This Section includes the following:
1. Concealed building insulation
2. Loose-fill building insulation
3. Vapor retarders.

1.2 QUALITY ASSURANCE

- A. Fire-Test-Retention Characteristics: Provide insulation and related materials with the fire-test-retention characteristics indicated, as determined by testing identical products per ASTM E 84 for surface burn characteristics, BUL or another testing and inspection agency acceptable to authorities having jurisdiction. Identify materials with appropriate markings of a label indicating testing and inspection agency.

PART 2 - PRODUCTS

2.1 INSULATING MATERIALS

- A. General: Provide insulation materials that comply with requirements and with referenced standards.
1. Molded-Polyurethane Insulation: ASTM C 578, Type I, 0.90 lb/cu ft, with maximum flame spread and smoke developed indices of 75 and 450, respectively. For use in non-rated masonry walls.
C. Mineral-fiber blanket insulation consisting of fibers manufactured from glass:
1. Faced Mineral-fiber blanket insulation: ASTM C 665, Type III, Class A, Cate/or II, faced with foil-sheathed kraft, foil-sheath, or foil-sheathed kraft, one vapor-retarder membrane on one face.
D. Perlite Loose-Fill Insulation: ASTM C 549, Type I or Type IV, with a thermal resistance for 4-1/2 to 7-1/2 inch thickness of 3.3 to 2.8 density of 11.5 to 13.5 lb/cu ft at 75 degrees Fahrenheit for 1-inch thickness. For use in rated masonry walls.
1. Manufacturer: Subject to compliance with requirements, provide products by one of the Producer Members of Perite Institute Inc.

2.2 VAPOR RETARDERS

- A. Polyethylene Vapor Retarder: ASTM D 4397, 8 mils thick, with maximum permeance rating of 0.13 perm.
1. Vapor-Retarder Tape: Pressure-sensitive type of type recommended by vapor-retarder manufacturer for use in joints and penetrations in vapor retarder.

2.3 AUXILIARY INSULATING MATERIALS

- A. Adhesive for bonding insulation: Product with demonstrated capability to bond insulation securely to substrates indicated without damage to insulation and substrates.

PART 3 - EXECUTION

- A. General: Install insulation to comply with insulation manufacturer's written instructions applicable to products and application indicated. Extend insulation in thickness indicated to an entire area to be insulated. Cut and fit insulation around obstructions and fittings with insulation. Remove projections that interfere with placement.
1. Polyurethane insulation into cavities indicated to receive insulation, take care to fit voids completely. Maintain inspection reports to show presence of insulation in entire area. Close joints after confirming complete coverage. Limit fit of insulation to one side; in both, but not exceeding 20 feet.
C. Installation of General Building Insulation: Apply insulation in place by method indicated, comply with manufacturer's written instructions. If no specific method is indicated, bond insulation to substrate with adhesive or use mechanical anchors to provide permanent placement and support of joints.

3.1 INSTALLATION

- 1. Seal joints between closed-cell nonbreathable insulation joints with adhesive, mastic, or sealant to edges of each joint to form a tight seal as joints are shored into place. Fill voids in completed installation with adhesive, mastic, or sealant.
2. Install mineral-fiber blankets in cavities formed by framing members according to the following requirements:
a. Use blanket widths and lengths that fill the cavities formed by framing members. If more than one blanket is required to fill cavity, provide lengths that will provide a snug fit between ends.
b. Place blankets in cavities formed by framing members to provide a friction fit between edges of insulation and adjoining framing members.
3. For metal-framed wall cavities where cavity height exceeds 96 inches, install unfaced blankets mechanically and support unfaced blankets by installing fan-eyes to fan-eyes of metal studs.
4. Retain insulation in place by metal clips and straps or interlocking ties within window frames, spaced at intervals as recommended in building insulation manufacturer's installation section in place with clips and straps. Maintain cavity width of dimension indicated between insulation and glass.
5. Installation where it contacts perimeter fire-containment system to prevent insulation from bowing under pressure from perimeter fire-containment system.

- 6. Place loose-fill insulation into spaces and onto surfaces as shown, either by blowing or by machine blowing to comply with ASTM C 1015. Leave horizontal applications to inform density as indicated. Blowing set to uniform density, blowing to compact excess.
7. Submit glass-fiber insulation into masonry voids and cavities as shown. Comply with appropriate 40 percent of normal maximum density of appropriate 2.5 lb/cu ft.

D. Installation of Vapor Retarders: Extend vapor retarder to extremities of areas to be protected from vapor transmission. Secure in place with adhesive or other anchorage system as indicated. Extend vapor retarder to cover masonry voids in insulated substrates, including those filled with loose-fill insulation.

- 1. Seal vertical joints in vapor retarders or framing blankets not less than two weeks. Fasten vapor retarders to framing at top, end, and bottom edges at perimeter of wall openings and at all joints. Space fasteners 16 inches on center.
2. Seal vertical joints in vapor retarders with adhesive or vapor-retarder tape according to vapor retarder manufacturer's instructions. Seal horizontal joints and fastener penetrations with vapor-retarder tape. Locate all joints over framing members or other solid substrates.
3. Firmly attach vapor retarders to substrates with mechanical fasteners or adhesives as recommended by vapor-retarder manufacturer.
4. Seal joints caused by ties, conduits, electrical boxes, and similar items penetrating vapor retarders with vapor-retarder tape to create an airtight seal between penetrating objects and vapor retarder.
5. Repair all tears or punctures in vapor retarders immediately before concealment by other work. Cover with vapor-retarder tape or another vapor retarder.

END OF SECTION 0710

SECTION 07410 - STANDING SEAM METAL ROOFING

PART 1 - GENERAL

1.1 DESCRIPTION

- A. Work includes Arkema Kynar 500 fluoropolymer coating system standing seam metal roofing materials and flashings and work incidental thereto required to complete and provide a watertight roofing system over all roof surfaces shown on the drawings.

B. Related work specified elsewhere:

- 1. Section 07210: Building Insulations
2. Section 07710: Sheet Metal Flashing and Trim

1.2 QUALITY ASSURANCE

- A. Have all work done by applicators approved by the manufacturer of the materials and installed in strict accordance with the manufacturer's direction, and all applicable requirements of Factory Mutual Engineering Corporation Standards, Class A, Type I.
B. Comply with requirements of Factory Mutual Loss Prevention Data 1-29 edition for resistance to wind blow-off in correlation with requirements in applicable building codes.

1.3 SUBMITTALS

- A. Product Data: Submit manufacturer's product information and installation instruction for each item used in roofing installation.

1.4 JOB CONDITIONS

- A. Weather: Conduct no roofing operations when water in any form is present on the deck, or when materials are damp, wet or likely to become damp or wet by the elements.

1.5 WARRANTY AND CERTIFICATION

- A. 30 year unconditional guarantee. The General Contractor shall furnish the Owner with a certified, written statement that roof deck and flashing attachments and all other conditions have been met as required to produce a bondable or guaranteed roofing and flashing application, and that it is in compliance with FM or UL classification requirements, all as have been included in these Specification and/or indicated on the drawings, or both.
B. Provide the Owner with the manufacturers written 30-year No Dollar Limit Roof System Guarantee. Contractor shall provide a 20-year workmanship guarantee, on the installation of the above roofing and components.

PART 2 - PRODUCTS

2.1 ROOFING SYSTEM

- A. Kynar 500 fluoropolymer coating system standing seam metal roofing panels with the appropriate base flashing and metal counter flashing or wall covering, as specified manufacturer's specifications. Roof shall be installed by a roofing Contractor authorized to install the specified Roof System.
B. 16" Wide 26 GA Pre-finished Integral Metal valleys and 2-1/2" 26GA. Integral Metal drip edge.
C. Finish to meet performance criteria of AAMA 2605 Specification.

PART 3 - EXECUTION

3.1 PREPARATION

- A. Make all sub-surfaces free from material projections, dust, loose and foreign materials and any other obstruction, presenting a smooth plane, ready for installation.
B. No roofing shall be applied until all vents, pipes, or roof mounted or protruding items have been installed in their final position and the general condition and acceptability of the deck surface to be covered has been determined by examination.
C. Commencing of roofing application shall constitute acceptance of the deck surface by roofing applicator.

3.2 INSTALLATION

- A. Standing seam metal roof system shall be installed on 30 lb felt paper approved by the roofing manufacturer, and installed in strict accordance with manufacturer's written specification.

3.4 FIELD QUALITY CONTROL

- A. When work is stopped at the end of the day, or when work is stopped because of the probability of precipitation, exercise care to ensure that water does not flow beneath completed sections of roof by sealing loose edge of roofing system in accordance with the roofing manufacturer's printed instruction.

3.5 CLEAN-UP

- A. Clean entire roof surface.
B. Promptly remove foreign matter, debris, equipment and surplus materials from job site.

END OF SECTION-

Table with 8 columns and 1 row for REVISIONS.

Table with 2 columns and 2 rows for PROJECT NO. and DATE.

GENERAL NOTES SPECIFICATIONS

NEW RETAIL CENTER FOR: KADMAR PLAZA ORLANDO, FLORIDA

RABITS & ROMANO ARCHITECTURE PLANNING AND DESIGN. Includes contact information: 5127 SOUTH ORANGE AVE., SUITE 110, ORLANDO, FL 32809. TEL: 407-496-0350, FAX: 407-232-6000. Website: www.rabits-architect.com

SIGN/SEAL DATE

CONSTRUCTION STANDARD SPECIFICATION

SECTION 07500  
SINGLE PLY ROOFING SYSTEM

Thermal Propylene Olefin (TPO)

PART 1 - GENERAL

1.01 Related Documents 2
1.02 Description of Work 2
1.03 References 2
1.04 Submittals 4
1.05 Quality Assurance 5
1.06 Delivery, Storage, And Handling 5
1.07 Project Conditions 6
1.08 Warranty 7

PART 2 - PRODUCTS

2.01 General 7
2.02 Membrane 7
2.03 Flashing Membrane 8
2.04 Insulation 8
2.05 Accessory Products 8

PART 3 - EXECUTION

3.01 Inspection 9
3.02 Preparation of Substrate 10
3.03 Installation of Insulation 10
3.04 Installation of Membrane 10
3.05 Membrane Flashings 11
3.06 Temporary Cutoff 11
3.07 Walkway Installation 12
3.08 Completion 13

CONSTRUCTION STANDARD SPECIFICATION

SECTION 07533

SINGLE PLY ROOFING SYSTEM - THERMAL PROPYLENE OLEFIN (TPO)

PART 1 - GENERAL

1.01 RELATED DOCUMENTS

- A. Drawings and general provision of the Contract, including General and Supplementary Conditions and Division 1 Specification Sections.
B. Related Sections include the following:
1. Section 07600 Flashing and Sheet Metal
2. Section 13100 Lightning Protection
3. Section 15401 Plumbing, for roof drains

1.02 DESCRIPTION OF WORK

- A. This section includes all material, labor, equipment, temporary protection and tools for the proper installation and completion of the work as required in this specification.
B. The following items are specified in this section:
1. Roof Insulation
2. Fasteners
3. Roof membrane
4. Roof membrane flashings
5. Treated Wood
6. Sealants
7. Adhesives

1.03 REFERENCES

- A. American Society of Testing and Materials (ASTM)
A653 Specification for Steel Sheet, Zinc-Coated (Galvanized) by the Hot-Dip Process, Commercial Quality
D413 Test Methods for Rubber Property-Adhesion of Flexible Substrate
D573 Test Method for Rubber-Deterioration in an Air Oven
D751 Test Methods for Coated Fabrics
D1149 Test Method for Rubber Deterioration-Surface Ozone Cracking in a Chamber
D1203 Test Methods for Volatile Loss from Plastics Using Activated Carbon Methods
D1204 Test Method for Linear Dimensional Changes of Nonrigid Thermoplastic Sheet or Film at Elevated Temperature
D2136 Test Method for Coated Fabrics-Low Temperature Bend Test
D2240 Test Method for Rubber Property-Durometer Hardness
E84 Test Method for Surface Burning Characteristics of Building Materials
E408 Standard Test Methods for Total Normal Emittance of Surfaces Using Infrared Radiation
E838 Practice for Performing Accelerated Outdoor Weathering Using Concentrated Natural Sunlight
E903 Standard Test Method for Solar Absorbance, Reflectance, and Transmittance of Materials Using Integrating Spheres
B. California South Coast Air Quality Management District (AQMD)
Rule 1168 Adhesive and Sealant Applications
C. California Bay Area Air Quality Management District (AQMD)
Regulation 8 Rule 81, Organic Compounds Adhesive and Sealant Products
D. Factory Mutual (FM)
Approval Guide
Approval Standard No. 4470 Class 1 Roof Covers
E. Federal Specification (FS)
HH-1-1972/2 Class 1 Insulation Board, Thermal Polyurethane or Polyisocyanurate, Faced with Asphalt/Glass Fiber Felt on Both Sides of the Foam
F. Federal Test Method (FTM)
FTM 101B Method 2031 Puncture Resistance
G. National Roofing Contractors Association (NRCA)
Roofing and Waterproofing Manual
H. Underwriter's Laboratories, Inc. (UL)
Roofing Materials and Systems Directory

1.04 SUBMITTALS

- A. Product Data: Submit manufacturer's technical product data, installation instructions and recommendations for each type of roofing product required. Include data substantiating that materials comply with the specified requirements.
B. Submit copy of the membrane manufacturer's warranty covering materials.
C. Submit copy of the Roofing Contractor's warranty covering workmanship.
D. Submit dimensioned shop drawings, which shall include:
1. An outline of the roof and roof size.
2. Proposed installation method for insulation and membrane for each different section of roof. Include insulation type (e.g. flat, tapered) and fastener patterns if applicable. Show Contractor's proposed method of achieving specified roof slopes.
3. Proposed profile details of flashing methods for penetrations and terminations if not indicated in the Contract Documents.
4. Proposed location of manufacturer approved walkpads. Corners are to be rounded and installed in accordance with manufacturer's written instructions. All side and end joints shall be hot-air welded a minimum of 2"-inch (51mm). No adhesive shall be present within the lap areas.
E. Submit report from an independent testing laboratory certifying that manufacturer's membrane has met a minimum of 2,000,000 largeley concentrated natural sunlight, according to ASTM E838.
F. Submit written documentation from the manufacturer that the proposed roofing system including insulation and fasteners are compatible and meet the applicable requirements and code approvals as referenced in this specification and that the roofing system meets the requirements for the manufacturers standard warranty covering material.
G. Submit certification that membrane installer is a manufacturer-approved applicator.
H. Submit manufacturer's documentation of Energy Star labeled roofing materials.
I. Submit Material Safety Data Sheets (MSDS) and manufacturer's documentation of Volatile Organic Compound (VOC) content for each adhesive and sealant product.
J. Submit manufacturer's documentation of recycled content for Polyisocyanurate insulation.

1.05 QUALITY ASSURANCE

- A. Roofing system shall be applied only by an approved Contractor authorized prior to bid by the roof membrane manufacturer. Prior to bid, the Roofing Contractor must have completed a minimum of 500 roofing squares of Thermal Propylene Olefin (TPO) membrane in the Southwest.
B. There shall be no deviation from this specification or the approved shop drawings without prior written approval by the manufacturer and the Sandia Delegated Representative (SDR).
C. Code Requirements: The proposed roofing system shall meet the requirements of the following recognized code approval or testing agencies. These requirements are the minimum standards and no roofing work shall commence without written documentation of the system's compliance, as in Article 1.03 "Submittals".
1. Underwriters Laboratories (UL) Class A membrane.
2. Factory Mutual (FM) I-90 uplift rating, per FM Approval Standard No. 4470.
D. Energy Star Roof Compliance: The proposed roofing system shall be Energy Star Roof-compliant and roofing materials shall be Energy Star labeled.
E. For new installations, ponding shall not occur in accordance with NRCA Roofing and Waterproofing manual good roof design practice, which dictates that there be no ponding of water 48 hours after rainfall.
F. There shall be no more than 20 patches per 10,000sf on new construction.

1.06 DELIVERY, STORAGE, AND HANDLING

- A. All products delivered to the job site shall be in the original unopened container or wrappings.
B. Membrane rolls and insulation shall be stored fully protected from moisture and wind damage. Remove plastic from insulation and cover with tarpaulins on a raised surface.
C. Bonding adhesives shall be stored at temperatures recommended by manufacturer.
D. Handle all materials to prevent damage. Any materials which are determined damaged, according to the SDR, are to be removed from the job site and replaced at no cost to Sandia National Laboratories (SNL).

1.07 PROJECT CONDITIONS

- A. Construction may not be fully represented on the drawings, and some modifications to details may be required to accomplish the intent of the documents.
1. Contractor shall ascertain to his satisfaction, coordinate with General Contractor and other subcontractors prior to bidding, that the specifications and drawings are workable and that they are not in conflict with the manufacturer's requirements for a material warranty.
B. All work shall be scheduled and executed without exposing the interior building areas to the effects of inclement weather. The existing building and its contents shall be protected against all risks, and any damages shall be repaired or replaced at no cost to SNL. All exterior lighting, equipment, landscaping and paving shall be protected from damage.
C. Contractor shall test drains per SDR's direction prior to and upon completion of roofing work to insure that no blockage exists or has occurred.
D. Only as much of the new roofing as can be made weather tight each day including all flashing work, shall be installed. Plug all roof drains before starting work each day and unplug all drains at the end of each workday.
E. All surfaces to receive insulation, membrane or flashing shall be thoroughly clean and dry. Should surface moisture occur, the Contractor shall provide the necessary equipment and labor to dry the surface prior to application.
F. All construction, including equipment and accessories, shall be secured against wind blow-off damage.
G. Temporary waterstops shall be installed at the end of each day's work and shall be removed before proceeding with the next day's work. Waterstops shall be compatible with all materials, shall not emit dangerous or incompatible fumes, and shall be installed per manufacturer's recommendations.
H. Contractor shall provide all necessary protection and barriers to segregate the work area and to prevent damage to adjacent areas. Plywood protection shall be provided for all new and existing roof areas which receive traffic during construction.
I. Contaminants, such as grease, fats, oils and solvents shall not be allowed to come into direct contact with the roofing membrane. Any exposures shall be presented to the membrane manufacturer for assessment of impact on the roof system performance.
J. Contractor shall take care during application and storage that overloading of deck and structure does not occur.
K. Precautions shall be taken when using adhesives at or near rooftop vents or air intakes. Coordinate closing or shut-offs of vents and air intakes during roofing and flashing operations.

1.08 WARRANTY

- A. Upon completion of construction, the manufacturer's ten (10) year warranty covering materials shall be issued to SNL.
B. Roofing Contractor shall supply SNL with a minimum two (2) year workmanship warranty. In the event any work related to roofing, flashings, or metal work is found to be defective or otherwise not in accordance with the Contract Documents within two (2) years of final acceptance, the roofing Contractor shall remove and replace the defects at no cost to SNL.

PART 2 - PRODUCTS

2.01 GENERAL

- A. Provide an insulated roofing system that is comprised of fully compatible components for use in the proposed application. All proposed materials shall be compatible with substrate.

2.02 MEMBRANE

- A. TPO: Polyester arim reinforced Thermal Propylene Olefin (TPO) sheet conforming to the following minimum physical properties:

Property ASTM Test Method Specification Color White Weight D7510.18 lbs/sq ft (0.88 kg/m^2) Nominal Thickness (min.) D7510.060" inch (1.52 mm) Breaking Strength (min.) D751 (Grab Method) 225 lbf (1.0 kN) Tear Strength (min.) D751 (Tongue Tear) 55 lbf (245 N) Low Temperature Bend D2136 Pass Shore A Hardness D2240 80-90 Aging D573 Maintains original strength Volatility, Max. Loss D1203, Method A0.5 % Hydrostatic Resistance (min.) D751, Method A300 psi (2.1 MPa) Ozone Resistance D1149 No Effect Emulsion Concentrated Natural Sunlight, 2 million largeley ESR No visible surface cracking or stiffening Dimensional Stability (max.) D1204 0.5 % Puncture Resistance (min.) FTM 101B, Method 2031 250 lbf (1.1 kN) 180 degree Peel

Strength (min.) D11335 lbf (516 N) Change in Weight After Immersion in Water (max.) D570 +3.0% Initial Solar Reflectance (min.) E903 0.55 3-year aged Solar Reflectance (min.) E903 0.50 Emissivity (min.) E1480 90 2.03 FLASHING MEMBRANE

- A. Flashing membrane shall be as supplied by the roofing membrane manufacturer. Flashing membranes are generally the same material as the roofing membrane unless otherwise specified in the Contract Documents. Unreinforced 0.055"-inch (1.4 mm) thick ethylene propylene - base membrane shall be supplied for vent stacks, pipes, drains and corners.

2.04 INSULATION

- A. General: Provide insulating material to comply with referenced standards and requirements indicated for materials; provide manufacturer's standard thickness, in size to fit applications.
1. Fully Adhered Systems: Provide no greater than 4'-feet x 4'-feet (1.2m x 1.2m) boards.
2. Mechanically Fastened Systems: Provide 4'-feet x 8'-feet (1.2m x 2.4m) boards.
B. Polyisocyanurate Board Roof Insulation: Furnish and install rigid, cellular thermal insulation with Polyisocyanurate closed-cell foam core and manufacturer's standard facing laminated to both sides to comply with PS HH-1-1972/2 Class 1. Provide in two (2) layers for a total thickness to meet an average R-value of 30.0, unless indicated elsewhere on the Contract Documents.
1. Surface Burning Characteristics: Comply with ASTM E84 with a maximum flame spread and smoke developed values of 25 and 145, respectively.
2. Recycled Content: Minimum 9 percent.
C. Insulation, fasteners and adhesive shall be supplied or approved by the roof membrane manufacturer for compatibility with the system and the required FM and UL requirements. Adhesives shall comply with VOC limits of California South Coast (AQMD) Rule #1168.
D. Recovery Board: Provide one half-inch (1/2"-inch, 13mm) Dens Deck, or approved equal, over all insulation and tapered insulation.

2.05 ACCESSORY PRODUCTS

- A. Flashing Adhesive: As specified by the membrane manufacturer to comply with VOC limits of California South Coast (AQMD) Rule #1168. Any adhesives containing carcinogens shall be limited to vertical surfaces and flashings.
B. Walkway Membrane: Membrane manufacturer's walkway material.
C. Wood Nailers: Wood shall be #2 or better preservative treated lumber usingCCA Preservatives. Height of nailers shall match that of the insulation thickness or as indicated on the drawings.
D. Sealants: As recommended by the membrane manufacturer to comply with VOC limits of California Bay Area (AQMD) Regulations.
E. Miscellaneous Fasteners and Anchors: In general, all fasteners, anchors, nails and straps shall be of zinc-coated steel, galvanized, or stainless steel and cadmium-free. All fasteners and anchors shall have a minimum embedment of 1-1/2"-inch (38 mm) and shall be approved for such use by the fastener manufacturer and the membrane manufacturer.
F. Sheet Metal Accessory Materials: ASTM A653, with 0.20 percent copper, G90 hot-dipped galvanized, 24 gauge (0.61 mm) or heavier.
G. Expansion Joint Covers: Shall be the manufacturer's prefabricated units of the same material as the roof membrane.
H. Perimeter Edge Metal: Shall be supplied by the membrane manufacturer and coated with the same material as the roofing membrane and shall be compatible with the roofing membrane for hot-air welding.
I. Slip Sheet: Provide only when needed between incompatible materials. Use membrane manufacturer's standard slip-sheet material.
J. Base Sheet: Provide membrane manufacturer's recommended vented base sheet on all types of concrete decks or when required or recommended by membrane manufacturer for the intended application.
K. B-Line Rooftop Supports or approved equal. To be placed at a minimum of 10'-feet (3m) on center for proper support. Refer to SNL Standard Detail Drawing for rooftop supports, AE5035 and AE5036.

PART 3 - EXECUTION

3.01 INSPECTION

- A. Prior to all work of this section, Contractor shall carefully inspect the installed work of all other trades and verify that all such work is complete to the point where this installation may properly commence.
B. Verify that work of other trades that penetrate the roof deck has been completed.
C. Verify that roofing system may be installed in strict accordance with all pertinent codes and regulations, the original design and the manufacturer's recommendations.
D. In the event of discrepancy, immediately notify the SDR.
E. Do not proceed with installation in areas of discrepancy until all such discrepancies have been fully resolved.
F. Upon starting the installation of a new roof, the SDR and the General Contractor and their subcontractor, if applicable, will designate a portion of the installation to be used as a mock up. This area will be the model of how the roof installation shall be installed. The mock up should include the insulation, a curb, flashing, parapet and an inside and outside corner along with a termination and lap seam.
G. Throughout the project and at completion, the SDR shall be allowed to inspect the roof, including probing as necessary to ensure proper installation.

3.02 PREPARATION OF SUBSTRATE

- A. General: Comply with the insulation and membrane manufacturer's instructions for preparation of the substrate to receive the roofing system.
B. Clean substrate of dust, debris, and other substances detrimental to the system work. Remove sharp projections.
C. Notify the SDR to inspect the substrate. Contractor shall not proceed with installation until the SDR has approved the substrate.

3.03 INSTALLATION OF INSULATION

- A. Insulation shall be installed according to the insulation manufacturer's instructions and shall be approved by the SDR and membrane manufacturer. Stagger joints between layers.
B. Insulation shall be neatly cut to fit around all penetrations and projections.
C. Install tapered insulation where applicable in accordance with insulation manufacturer's approved shop drawings in order to achieve the specified slope.
D. Install tapered insulation around drains creating a drain sump.
E. Do not install more insulation board than can be covered with membrane by the end of the day, or onset of inclement weather.
F. Attachment
1. Insulation shall be mechanically fastened to the deck with approved fasteners and plates at a rate and pattern acceptable to Factory Mutual's and membrane manufacturer's requirements for fastening rates and patterns.
2. Fasteners are to be installed in accordance with the fastener manufacturer's recommendations. Fasteners are to have a minimum penetration into the structural deck as recommended by the fastener manufacturer and membrane manufacturer. Fasten only in top ribs of metal deck, not flutes.
3. Perform pull out tests for the SDR to verify deck conditions and actual pull out values prior to installation of the membrane.
4. Use fastener tools with a depth locator as recommended or supplied by the fastener manufacturer to ensure proper installation.

3.04 INSTALLATION OF MEMBRANE

- A. Install materials in accordance with manufacturers instructions for the intended application.
B. Surface of the insulation shall be inspected prior to installation of the roof membrane. The insulation surface shall be clean and smooth with no excessive surface roughness, contaminated surfaces, or unsound surfaces such as broken or delaminated insulation boards.
C. Membrane shall be installed per the membrane manufacturer's written installation procedures for an approved mechanically fastened system.
D. No bonding adhesive shall be applied to lap areas that are to be welded to flashing or adjacent sheets. All sheets shall be applied in the same manner, lapping all sheets as required by welding techniques. No peel and stick products allowed.
E. Any repairs or patches shall be hot-air welded. No peel and stick products allowed.
F. Adjacent sheets shall be welded in accordance with the manufacturer's written instructions.
G. Hand and machine welding shall be carried out per the manufacturer's written instructions. All mechanics intending to use the welding equipment shall have successfully completed a course of instruction provided by a manufacturer's representative prior to welding. All welding equipment must be approved by the manufacturer prior to use.
H. All completed seams shall be checked by the Contractor after cooling for continuity using a screwdriver or suitable blunt instrument. In addition, on-site evaluation of welded seams shall be made by Contractor at locations as directed by the SDR or membrane manufacturer's representative. Contractor shall provide 2"-inch (51 mm) wide cross-sectional samples taken through completed seams. Approximately two samples will be taken per 100 roofing squares. Correctly welded seams display failure from shearing of the membrane prior to separation of the weld. Each test cut shall be patched by the Contractor at no additional charge to SNL.

- I. Exposed or cured membrane shall be hot-air welded per manufacturer's instructions.
J. During the course of the work, the entire roof area shall be kept clear of loose or spilled fasteners and metal scraps to guard against accidental puncture of the membrane.

3.05 MEMBRANE FLASHINGS

- A. All flashing shall be installed concurrently with the roof membrane as the job progresses. No temporary membrane flashings shall be allowed without the prior written approval of the SDR. Approval shall only be for specific locations on specific dates.
B. All flashing membranes shall be fully adhered to substrates. All interior and exterior corners and miters shall be cut and hot-air welded in place, or prefabricated corners and miters may be used.
1. Bituminous elements shall not be in contact with non-compatible membrane. Manufacturers recommended isolator shall be used to isolate non-compatible membrane flashing from bituminous coated elements such as vent stacks and pipes penetrating the roof.
C. All flashings shall be hot-air welded at their joints and at their connections with the roof membrane. No peel and stick products allowed.
D. Pipe penetrations shall be flashed a minimum of 8"-inches (203 mm) above the roofing membrane, and terminate with a stainless steel hose clamp with sealant applied along the top edge. Pipe should be isolated by membrane. Factory fabricated pipe seals and roof membrane shall be welded as outlined. A buffer layer of membrane shall be installed between hose clamp and flashing sheet to avoid damage.
E. All curb flashing membranes shall be mechanically fastened along the top using nails with 1"-inch (25 mm) diameter heads spaced a maximum of 6"-inches (152 mm) on center, or prefilled metal strips. All roof edge flashings shall be hot-air welded to the membrane manufacturer's coated metal. Prefilled metal strips shall be caulked along the top edge with a sealant. Expansion pins with nylon sheaths set in prefilled holes shall be used to secure flashings to masonry and concrete surfaces. Reglets shall be used on walls as shown on the Contract Documents.
F. Edge metal shall be supplied by the membrane manufacturer and shall be coated with the same material as the roofing membrane. The edge metal and membrane strips joining each piece of edge metal shall closely match the color of the building perimeter, unless specified elsewhere on the Contract Documents or by the SDR.

3.06 TEMPORARY CUT-OFF

- A. Flashings shall be installed concurrently with the roof membrane in order to maintain a watertight condition as the work progresses. When a break in the day's work occurs in the central area of the roof, a temporary waterstop shall be constructed to provide a watertight seal.
1. Waterstop shall be installed per the manufacturer's recommendations and per details shown on the Contract Documents.
2. When work on the new system is suspended, the stagger of the insulation joints shall be maintained by installing partial fillers. New membrane shall be carried into the waterstop.
3. When work resumes, the contaminated membrane, insulation fillers, etc., shall be removed from the work area and disposed off-site. Do not reuse these materials in new work.
B. If inclement weather occurs while a temporary waterstop is in place, the Contractor shall provide the labor necessary to monitor the situation to maintain a watertight condition.

3.07 WALKWAY INSTALLATION

Walkways: Install walkway pads at location shown on Construction Documents. Hot-air weld along edges a minimum of 2"-inches (51mm) to substrate, and fully adhere walkway pads between welds to substrate with compatible adhesive according to roofing system manufacturer's written instruction. Corners of walkway are to be rounded and hot-air welded in accordance with manufacturer's written instruction.

3.08 COMPLETION

- A. At the completion of construction and prior to Contractor's request for final inspection by SDR, membrane manufacturer's technical consultant shall provide on-site inspection of installed roofing system.
1. Membrane manufacturer shall provide Contractor and SDR with itemized list of defects or non-compliance with manufacturer's recommendations.
2. Contractor shall immediately correct identified items. Complete corrections before request for final inspection from SDR.
B. Prior to demobilization from site, work shall be reviewed by SDR and Contractor.
1. Itemize defects or non-compliance with these specifications or membrane manufacturer's recommendations in punch list.
2. Contractor shall immediately correct identified items prior to demobilization, to satisfaction of SDR and membrane manufacturer.
C. Upon completion of construction, the Contractor shall install a metal sign (minimum size of 8" x 10", or 203mm x 254mm) at each roof entryway providing the following information:
1. Contractor Company Name
2. Membrane Manufacturer
3. SNL Inspector Name
4. Date of Installation

END OF SECTION

Table with 8 columns: REVISIONS, PROJECT NO. 17CS0803-01, DATE 07/09/2018

GENERAL NOTES SPECIFICATIONS

NEW RETAIL CENTER FOR KADMAR PLAZA ORLANDO, FLORIDA

RABITS & ROMANO ARCHITECTURE PLANNING AND DESIGN info@rabits-architect.com www.rabits-architect.com TEL: 407-994-0350 FAX: 407-232-6000 5127 SOUTH ORANGE AVE. SUITE 110 ORLANDO, FL 32809

SIGN/SEAL DATE SHEET GN03 OF 33







2.5 JOINT TREATMENT MATERIALS

- A. General: Comply with ASTM C 475.
B. Joint Tape:
1. Interior Gypsum Wallboard: Paper.
2. Exterior Gypsum Soffit Board: Paper.
3. Glass-Mat Gypsum Sheathing Board: 10-by-10 glass mesh
C. Joint compound for interior gypsum wallboard: for each coat use formulation that is compatible with other compounds applied on previous or for successive coats.
1. Prefilling: At open joints and damaged surface areas, use setting-type taping compound.
2. Embedding and First Coat: For embedding tape and first coat on joints, flanges of trim accessories, and fasteners, use setting-type taping compound.
3. Fill Coat: For second coat, use setting-type, sandable topping compound.
4. Finish Coat: For third coat, use setting-type, sandable topping compound.
5. Skim Coat: For final coat of Level 5 finish, use setting-type, sandable topping compound.
D. Joint Compound for Exterior Applications:
1. Exterior Gypsum Soffit Board: Use setting-type taping and setting-type, sandable topping compounds.
2. Glass-Mat Gypsum Sheathing Board: As recommended by manufacturer.
E. Joint Compound for Tile Backing Panels:
1. Water-Resistant Gypsum Backing Board: Use setting-type taping and setting-type, sandable topping compounds.
2. Glass-Mat, Water-Resistant Backing Panel: As recommended by manufacturer.
3. Cementitious Backer Units: As recommended by manufacturer.

2.6 AUXILIARY MATERIALS

- A. General: Provide auxiliary materials that comply with referenced installation standards and manufacturer's written recommendations.
1. Use screws complying with ASTM C 954 for fastening panels to steel members from 0.033 to 0.112 inch (0.84 to 2.84 mm) thick.
2. For fastening cementitious backer units, use screws of type and size recommended by panel manufacturer.

PART 3 - EXECUTION

3.1 NON-LOAD-BEARING STEEL FRAMING INSTALLATION

- A. General: Comply with ASTM C 754, and ASTM C 840 requirements that apply to framing installation.
B. Suspended Ceiling and Soffit Framing:
1. Suspend ceiling hangers plumb and free from contact with insulation or other objects within ceiling plenum that are not part of supporting structural or ceiling suspension system. Splay hangers only where required to miss obstructions and offset resulting horizontal forces by bracing, countersplaying, or other equally effective means.
2. Where width of ducts and other construction within ceiling plenum produces hanger spacings that interfere with the location of hangers required to support standard suspension system members, install supplemental suspension members and hangers in form of trapezes or equivalent devices. Size supplemental suspension members and hangers to support ceiling loads within performance limits established by referenced standards.
3. Attach hangers to structural members. Do not support ceilings from or attach hangers to permanent metal forms, steel deck tabs, steel roof decks, ducts, pipes, or conduit.
4. Screw furring to wood framing.
5. Wire-tie furring channels to supports, as required to comply with requirements for assemblies indicated.
6. Grid Suspension System: Attach perimeter wall track or angle where grid suspension system meets vertical surfaces. Mechanically join main beam and cross-furring members to each other and buttcut to fit into wall track.
C. Partition and Soffit Framing:
1. Where studs are installed directly against exterior walls, install isolation strip between studs and wall.
2. Extend partition framing full height to structural supports or substrates above suspended ceilings, except where partitions are indicated to terminate at suspended ceilings. Continue framing over frames for doors and openings and frame around ducts penetrating partitions above ceiling to provide support for gypsum board.
3. Frame door openings to comply with GA-600 and with gypsum board manufacturer's applicable written recommendations, unless otherwise indicated. Screw vertical studs at jacks to jamb anchor clips on door frames; install runner track section (for cripple studs) at head and secure to jamb studs.
a. Install two studs at each jamb, unless otherwise indicated.
b. Extend jamb studs through suspended ceilings and attach to underside of floor or roof structure above.
4. Frame openings other than door openings the same as required for door openings, unless otherwise indicated. Install framing below sills of openings to match framing required above door heads.

3.2 PANEL PRODUCT INSTALLATION

- A. Gypsum Board: Comply with ASTM C 840 and GA-216.
1. Space screws a maximum of 12 inches o.c. for vertical applications.
2. On ceilings, apply gypsum panels before wall partition board application to the greatest extent possible and at right angles to framing, unless otherwise indicated.
3. On partitions/walls, apply gypsum panels vertically (parallel to framing), unless otherwise indicated or required by fire-resistance-rated assembly, and minimize end joints.
a. Stagger abutting end joints not less than one framing member in alternate courses of board.
b. At stairwells and other high walls, install panels horizontally, unless otherwise indicated or required by fire-resistance-rated assembly.
4. Single-Layer Fastening Methods: Apply gypsum panels to supports with steel drill screws.
5. Laminating to Substrate: Comply with gypsum board manufacturer's written recommendations and temporarily brace or fasten gypsum panels until fastening adhesive has set.
B. Exterior Ceilings and Soffits: Apply exterior gypsum panels perpendicular to supports, with end joints staggered and located over supports.
1. Fasten with corrosion-resistant screws.

3.3 FINISHING

- A. Installing Trim Accessories: For trim with back flanges intended for fasteners, attach to framing with same fasteners used for panels. Otherwise, attach trim according to manufacturer's written instructions.
B. Finishing Gypsum board panels: treat gypsum board joints, interior angles, edge trim, control joints, penetrations, fastener heads, surface defects, and elsewhere as required to prepare gypsum board surfaces for decoration.
1. Prefill open joints and damaged surface areas.
2. Apply joint tape over gypsum board joints, except those with trim having flanges not intended for tape.
3. Glass-Mat Gypsum Sheathing Board: Finish according to manufacturer's written instructions for use as exposed soffit board.
4. Glass-Mat, Water-Resistant Backing Panels: Finish according to manufacturer's written instructions.
C. Gypsum Board Finish Levels: Finish panels to levels indicated below, according to ASTM C 840, for locations indicated:
1. Level 4: Embed tape and apply separate first, fill, and finish coats of joint compound to tape, fasteners, and trim flanges at panel surfaces that will be exposed to view, unless otherwise indicated.

END OF SECTION 09260

SECTION 09512 - ACOUSTICAL TILE CEILINGS

PART 1 - GENERAL

1.1 SUMMARY

- A. This Section includes acoustical tiles and concealed suspension systems for ceilings.

1.2 SUBMITTALS

- A. Product Data: For each product indicated.
B. Samples: For each acoustical tile, for each concealed suspension system member and for each color and texture required.
C. Product test reports.

1.3 QUALITY ASSURANCE

- A. Acoustical Testing Agency Qualifications: An independent testing laboratory or an NVLAP-accredited laboratory.
B. Fire-Test-Response Characteristics:
1. Fire-Resistance Ratings: Where indicated, provide acoustical tile ceilings identical to those of assemblies tested for fire resistance per ASTM E 119 by UL or another testing and inspecting agency acceptable to authorities having jurisdiction. Ratings are indicated by design designations from UL's "Fire Resistance Directory" or from the listings of another testing and inspecting agency.
a. Identify materials with appropriate markings of applicable testing and inspecting agency.
2. Surface-Burning Characteristics: Acoustical tiles complying with ASTM E 1264 for Class A materials, when tested per ASTM E 84.
a. Smoke Developed Index: 450 or less.
C. Seismic standard: Comply the following
1. ASTM E 580.
2. CISCA's "Recommendations for Direct-Hung Acoustical Tile and Lay-in Panel Ceilings--Seismic Zones 0-2."
3. Mockups: Build mockups to verify selections made under sample Submittals and to

PART 2 - PRODUCTS

2.1 MANUFACTURERS

- A. In other Part 2 articles where titles below introduce lists, the following requirements apply for product selection:
1. Available Products: Subject to compliance with requirements, products that may be incorporated into the Work include, but are not limited to, the products specified.

2.2 GENERAL

- A. Acoustical Tile Standard: Comply with ASTM E 1264.
B. Metal Suspension System Standard: Comply with ASTM C 635.
C. Attachment Devices: Size for five times the design load indicated in ASTM C 635, Table 1, "Direct Hung," unless otherwise indicated.
1. Anchors in Concrete: Expansion anchors fabricated from corrosion-resistant materials, with holes or loops for attaching hangers of type indicated and with capability to sustain, without failure, a load equal to five times that imposed by ceiling construction, as determined by testing per ASTM E 488 or ASTM E 1512 as applicable, conducted by a qualified testing and inspecting agency.
2. Power-Actuated Fasteners in Concrete: Fastener system of type suitable for application indicated, fabricated from corrosion-resistant materials, with clips or other accessory devices for attaching hangers of type indicated, and with capability to sustain, without failure, a load equal to 10 times that imposed by ceiling construction, as determined by testing per ASTM E 1190, conducted by a qualified testing and inspecting agency.
D. Wire Hangers, Braces, and Ties: Zinc-coated carbon-steel wire; ASTM A 641, A 641M, Class 1 zinc coating, soft temper.
1. Size: Select wire diameter so its stress at three times hanger design load (ASTM C 635, Table 1, "Direct Hung") will be less than yield stress of wire, but provide not less than 0.106-inch-diameter wire.
E. Seismic struts and seismic clips.
F. Metal Edge Moldings and Trim: Type and profile indicated or, if not indicated, manufacturer's standard moldings for edges and penetrations that fit acoustical tile edge details and suspension systems indicated; formed from sheet metal of same material and finish as that used for exposed flanges of suspension system runners.

2.3 ACOUSTICAL TILES

- A. General: Acoustical tiles shall be 24" x 48" x 5/8" matte finish mineral fiber ceiling boards and shall conform to Federal Specification SS-5-1 18a, Class 25. Light reflectance shall be no less than 75% and have NRC minimum range of .50 -.60.
B. Products:
1. Armstrong "Cortega".
2. Celotex "Baroque".
3. U.S.G. "Omni Fissured"

2.4 METAL SUSPENSION SYSTEM

- A. General: The ceiling suspension system shall be an exposed grid system with exposed flanges having a factory applied white enamel finish with roll formed capped edges.
1. Main Runner: DX-24
2. Cross Tees: DX-424
3. Wall Angle: M65
B. Products:
1. Donn Products, Inc., Westlake, OH.
2. Acoustical Tile Supplier Standard Grid System.
B. Ceiling Suspension System: Direct hung; ASTM C 635, Intermediate-duty structural classification.

PART 3 - EXECUTION

3.1 INSTALLATION

- A. General: Install acoustical tile ceilings to comply with ASTM C 636 and seismic requirements indicated, per manufacturer's written instructions and CISCA's "Ceiling Systems Handbook."
B. Measure each ceiling area and establish layout of acoustical tiles to balance border widths at opposite edges of each ceiling. Avoid using less-than-half-width tiles at borders.
C. Suspend ceiling hangers from building's structural members, plumb and free from contact with insulation or other objects within ceiling plenum. Splay hangers only where required to miss obstructions; offset resulting horizontal forces by bracing, countersplaying, or other equally effective means. Where width of ducts and other construction within ceiling plenum produces hanger spacings that interfere with location of hangers, use trapezes or equivalent devices.
1. Do not support ceilings directly from permanent metal forms or floor deck; anchor into concrete slabs.
2. Do not attach hangers to steel deck tabs or to steel roof deck.
D. Install edge moldings and trim at perimeter of acoustical tile ceiling area and where necessary to conceal edges of acoustical units. Screw attach moldings to substrate with concealed fasteners at intervals not more than 16 inches o.c. and not more than 3 inches from ends, leveling with ceiling suspension system to a tolerance of 1/8 inch in 12 feet. Miter corners accurately and connect securely.
E. Install suspension system runners so they are square and securely interlocked with one another. Remove and replace dented, bent, or kinked members.
F. Install acoustical tiles in coordination with suspension system and exposed moldings and trim. Place spines or suspension system flanges into curved edges so tile-to-tile joints are closed by double lay of material. Fit adjoining tile to form flush, tight joints. Scribe and cut tile for accurate fit at borders and around penetrations through tile. Hold tile field in compression by inserting leaf-type, spring-steel spacers between tile and moldings, spaced 12 inches o.c.

END OF SECTION 09512

SECTION 10200 - LOUVERS AND VENTS

PART 1 - GENERAL

1.1 SUMMARY

- A. This Section includes fixed, extruded-aluminum louvers.

1.2 PERFORMANCE REQUIREMENTS

- A. Structural Performance: Provide louvers capable of withstanding the effects of gravity loads and wind loads based on a uniform pressure of 20 lb/sq. ft., acting inward or outward, without permanent deformation of louver components, noise or metal fatigue caused by louver blade rattle or flutter, or permanent damage to fasteners and anchors.
B. Thermal Movements: Provide louvers that allow for thermal movements resulting from a temperature change (range) of 120 deg F, ambient; 180 deg F, material surfaces, by preventing buckling, opening of joints, overstressing of components, failure of connections, and other detrimental effects.
C. Air-Performance, Water-Penetration, and Wind-Driven Rain Ratings: As demonstrated by testing manufacturer's stock units according to AMCA 500-L.

1.3 SUBMITTALS

- A. Product Data: For each type of product indicated.
B. Shop Drawings: Include plans, elevations, sections, details, and attachments to other Work.
1. Verify louver openings by field measurements before fabrication and indicate measurements on Shop Drawings.
C. Samples: For each type of finish upon request of Architect.
D. Product test reports verifying compliance with applicable wind loads by testing methods approved by the authority having jurisdiction.

PRODUCTS

2.1 MANUFACTURERS

- A. Available Manufacturers: Subject to compliance with requirements, manufacturers offering products that may be incorporated into the Work include, but are not limited to, the following:
1. Louvers:
a. Airline Products Co.
b. Cesco Products.
c. Greenheck.
d. Vent Products Company, Inc.

2.2 MATERIALS

- A. Aluminum Extrusions: ASTM B 221, alloy 6063-T5 or T-52.
B. Aluminum Sheet: ASTM B 209, alloy 3003 or 5005.
C. Fasteners: Of same basic metal and alloy as fastened metal or 300 Series stainless steel.

2.3 FABRICATION, GENERAL

- A. Fabricate frames to fit in openings of sizes indicated, with allowances made for fabrication and installation tolerances, adjoining material tolerances, and perimeter sealant joints.
1.
B. Join frame members to each other and to louver blades with fillet welds concealed from view.
C. Join frame members to each other and to louver blades with fillet welds, threaded fasteners, or both, as standard with louver manufacturer, concealed from view.

2.4 FIXED, EXTRUDED-ALUMI-NIUM LOUVERS

- A. Horizontal, Nondrainable-Blade Louver:
1. Basis-of-Design Product: Greenheck ESU or a comparable product of one of the following:
a. Airline Products Co.
b. Cesco Products.
c. Vent Products Company, Inc.
2. Blade Profile: Plain blade without center baffle.
3. Frame and Blade Nominal Thickness: Not less than 0.080 inch.
4. Performance Requirements:
a. Free Area: Not less than 7.5 sq. ft. for 48-inch-wide by 48-inch-high louver.
b. Point of Beginning Water Penetration: Not less than 700 fpm.
c. Air Performance: Not more than 0.10-inch wg static pressure drop at free-area velocity.

2.5 LOUVER SCREENS

- A. General: Provide screen at interior face of each exterior louver.
B. Louver Screen Frames: Same kind and form of metal as indicated for louver to which screens are attached.
C. Louver Screening:
1. Bird Screening: Aluminum, 1/2-inch-square mesh, 0.063-inch wire.

2.6 FINISHES

- D. Aluminum, High-Performance Organic Finish: Two-coat thermocured system with fluoropolymer coats containing not less than 70 percent polyvinylidene fluoride resin by weight; complying with AAMA 2605.
1. Color and Gloss: As selected from manufacturer's full range.

PART 3 - EXECUTION

3.1 INSTALLATION

- A. Locate and place louvers and vents level, plumb, and at indicated alignment with adjacent work.
B. Use concealed anchorages where possible. Provide brass or lead washers fitted to screws where required to protect metal surfaces and to make a weather tight connection.
C. Provide perimeter reveals and openings of uniform width for sealants and joint fillers, as indicated.
D. Repair damaged finishes so no evidence remains of corrective work. Return items that cannot be refinished in the field to the factory, make required alterations, and refinish entire unit or provide new units.
E. Protect galvanized and nonferrous-metal surfaces from corrosion or galvanic action by applying a heavy coating of bituminous paint on surfaces that will be in contact with concrete, masonry, or dissimilar metals.

END OF SECTION 10200

SECTION 10801 - TOILET AND BATH ACCESSORIES

PART 1 - GENERAL

1.1 SUMMARY

- A. This Section includes the following:
1. Toilet and bath accessories.
2. Underlayment guards.

1.2 QUALITY ASSURANCE

- A. Inserts and Anchorage: Furnish inserts and anchoring devices and coordinate delivery with other work to avoid delay.
B. Provide products of the same manufacturer for each type of accessory unit and for units exposed in the same areas.
C. Special Mirror Warranty: Manufacturer's standard form in which manufacturer agrees to repair or replace mirrors that develop visible silver spoilage defects within 15 years from date of Substantial Completion.

PART 2 - PRODUCTS

2.1 MANUFACTURERS

- A. Manufacturers: Subject to compliance with requirements, provide products by one of the following:1. Toilet and Bath Accessories:
a. American Specialties, the.
b. Bobrick Washroom Equipment, Inc.
c. Bradley Corporation.
2. Underlayment Guards:

- a. Truebro, Inc.
b. Plumberex Specialty Products, Inc.

2.2 SCHEDULE OF TOILET ACCESSORIES

Table with columns: Mark Product, Bobrick #, Bradley #, Notes, and Accessory. Rows include Paper Towel Dispenser, Toilet Tissue Dispenser, Grab Bar, Mirror Unit, and Undersink Pipe Protection.

PART 3 - EXECUTION

3.1 INSTALLATION

- A. Install accessories using fasteners appropriate to substrate indicated and recommended by unit manufacturer. Install units level, plumb, and firmly anchored in locations and at heights indicated. Provide blocking where required to meet force requirements indicated below. Ensure blocking is fire retardant in walls that are rated or are otherwise required to be non-combustible.
1. Install grab bars to withstand a downward load of at least 250 lbf, when tested according to method in ASTM F 446.
2. Install undersink protection around trap and angle valve assemblies. Secure covers with manufacturer's standard fasteners.
B. Adjust accessories for unencumbered, smooth operation and verify that mechanisms function properly. Replace damaged or defective items. Remove temporary labels and protective coatings.

END OF SECTION 10801

REVISIONS table with columns for revision number and description.

PROJECT NO. 17309809-01 and DATE 07/09/09

GENERAL NOTES SPECIFICATIONS

NEW RETAIL CENTER FOR: KADMAR PLAZA ORLANDO, FLORIDA

RABITS & ROMANO ARCHITECTURE PLANNING AND DESIGN. Includes contact information for the firm.

SIGN/SEAL and DATE fields.

SHEET G101 OF 33



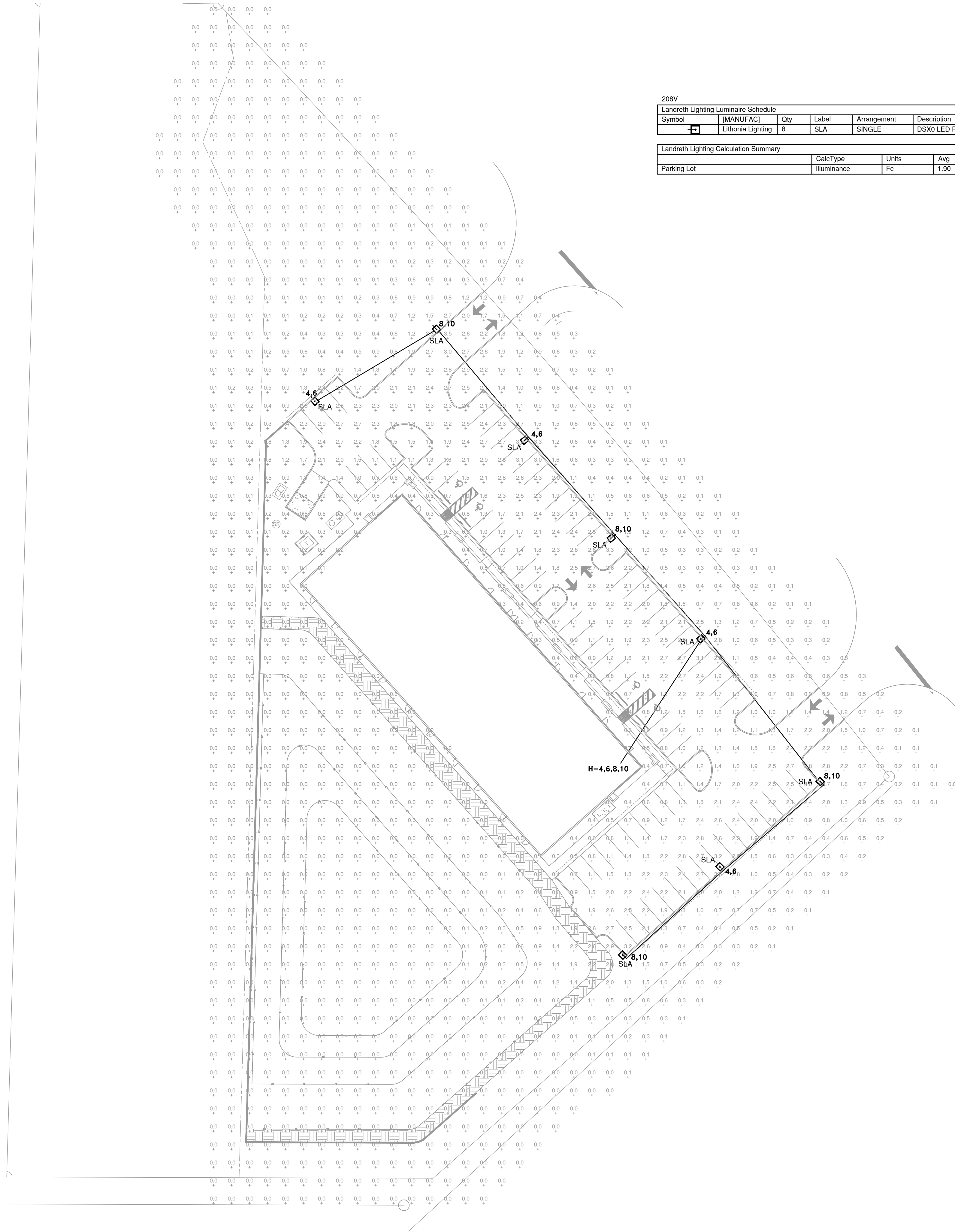

208V

Landreth Lighting Luminaire Schedule						LLF	Lum. Watts	Lum. Lumens	BUG Rating
Symbol	[MANUFAC]	Qty	Label	Arrangement	Description	1.000	89	11679	B2-U0-G2
	Litonia Lighting	8	SLA	SINGLE	DSX0 LED P5 40K TFTM MVOLT; MOUNTED @ 20' AFG ON A ROUND TAPERED DIRECT BURY ALUMINUM POLE				

Landreth Lighting Calculation Summary						
	CalcType	Units	Avg	Max	Min	Avg/Min
Parking Lot	Illuminance	Fc	1.90	3.7	0.6	3.17

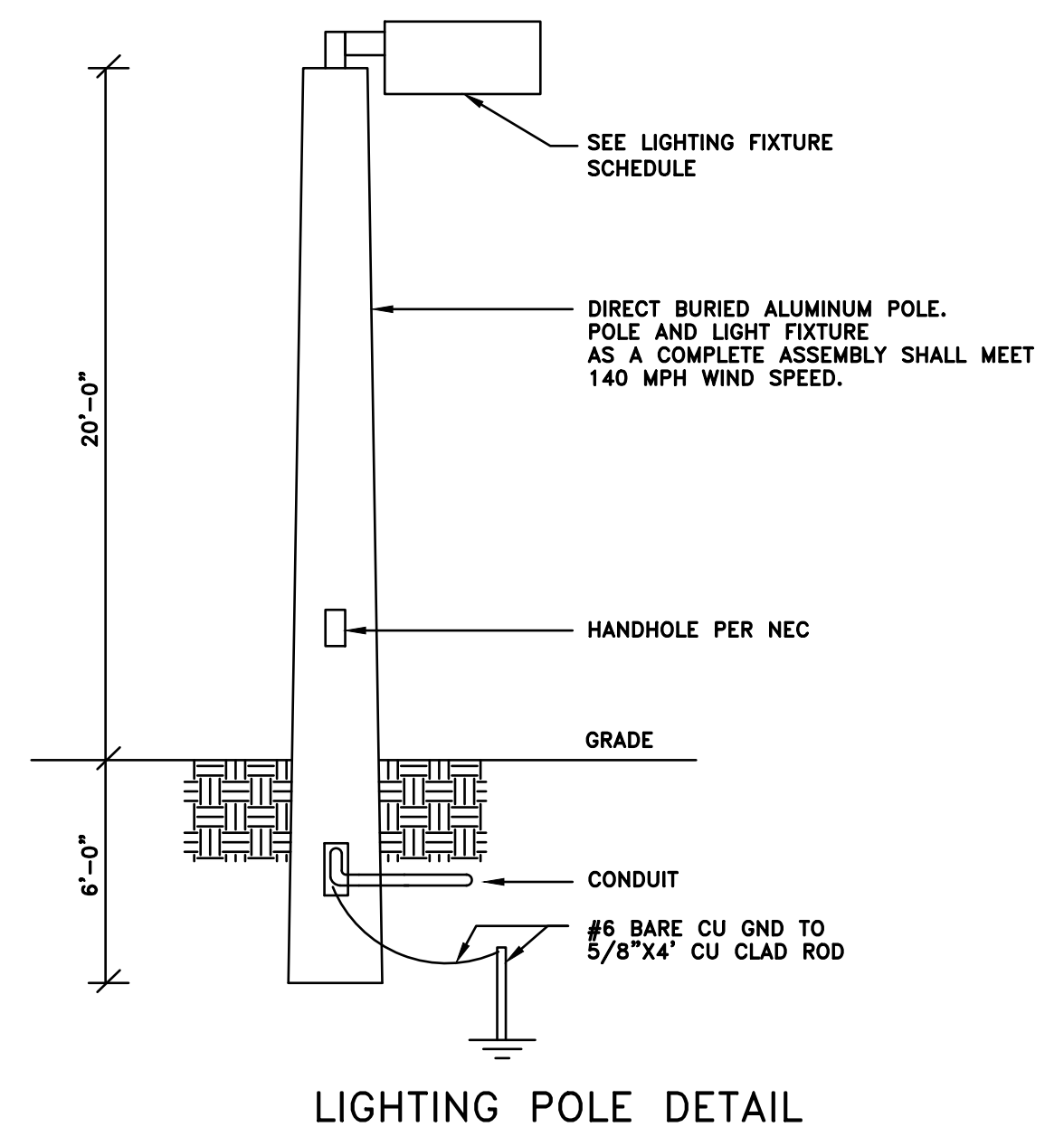

**SITE PLAN - ELECTRICAL**

SCALE: 1/32" = 1'-0"



**STOFFER & ASSOCIATES, INC.**  
CONSULTING ENGINEERS CA #26069  
10381 Hart Branch Circle Orlando, Florida 32832  
Randall D. Stoffer, P.E. PE #37367  
Phone (407) 381-4555 Fax (407) 249-1520  
ELECTRICAL - HVAC - PLUMBING

REV	BY	DATE
1		
2		
3		
4		
5		
6		
7		
8		

PROJECT NO.	173581803-01
DATE	06/07/2015

SITE PLAN-ELECTRICAL

NEW RETAIL CENTER FOR:  
**KADMAR PLAZA**  
ORLANDO, FLORIDA

**RABITS & ROMANO ARCHITECTURE**  
PLANNING AND DESIGN  
5127 SOUTH ORANGE AVE. SUITE 110 ORLANDO, FL 32809  
TEL: -407-490-0350 FAX: -407-232-6000  
info@rabits-architect.com www.rabits-architect.com

SIGN/SEAL

DATE

SHEET  
**ES-1**  
OF

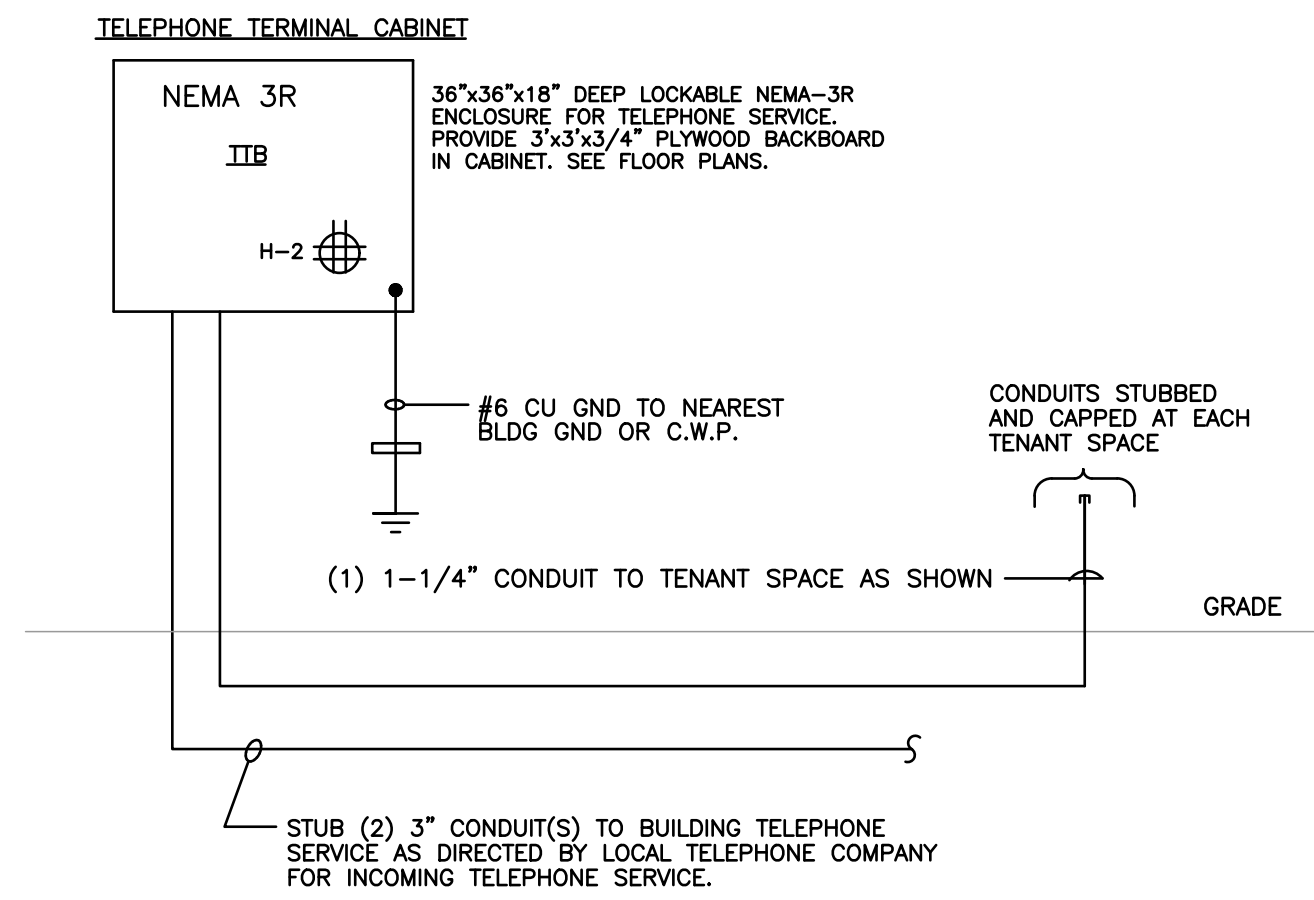

**KEYED NOTES**

- ① 3/4" C. STUBBED TO TENANT CEILING SPACE FOR FUTURE ROOF RECEPTACLE.
- ② 3-1/2" C. STUBBED AND CAPPED TO TENANT SPACE AS SHOWN FOR FUTURE PANEL FEEDER.
- ③ 1-1/4" C. STUBBED AND CAPPED TO TENANT SPACE AS SHOWN FOR FUTURE TELEPHONE SERVICE.
- ④ PROVIDE NEMA 3R 60A, 3PH D.S.S. ROUTE 1" C. STUBBED TO TENANT CEILING SPACE FOR FUTURE RTU CONNECTION.

- GENERAL ELECTRICAL NOTES**
1. THESE PLANS COMPLY WITH FBC-EC C405.6.3 WITH A MAXIMUM VOLTAGE DROP FOR FEEDER AND BRANCH CIRCUIT CONDUCTORS COMBINED DO NOT EXCEED A 5% VOLTAGE DROP.
  2. RECORD DRAWINGS. CONTRACTOR SHALL COMPLY WITH FBC-EC C405.6.4.1 WITHIN 30 DAYS AFTER THE DATE OF SYSTEM ACCEPTANCE.
  3. MANUALS. CONTRACTOR SHALL COMPLY WITH FBC-EC C405.6.4.2.
  4. ANY 120V DKT LONGER THAN 75 FEET, INCREASE TO #10 AWG.
  5. PROVIDE SERVICE EQUIPMENT A/C MARKING PER NEC 110.24(A) AND 110.24(B) FOR MODIFICATIONS IF REQUIRED.
  6. CONTRACTOR SHALL PROVIDE A LETTER FROM POWER CO. SHOWING THE AVAILABLE FAULT CURRENT AT THE SECONDARY OF THE TRANSFORMER. THIS LETTER SHALL BE SUBMITTED TO ORANGE COUNTY PRIOR TO THE 1ST INSPECTION. THIS LETTER SHALL ALSO BE SUBMITTED TO THE ENGINEER OF RECORD DURING SUBMITTAL REVIEW.

**COMMUNICATIONS SYSTEM  
RACEWAY RISER DIAGRAM**

ALL CONDUIT TO BE 3/4" C. MINIMUM UNLESS NOTED OTHERWISE.

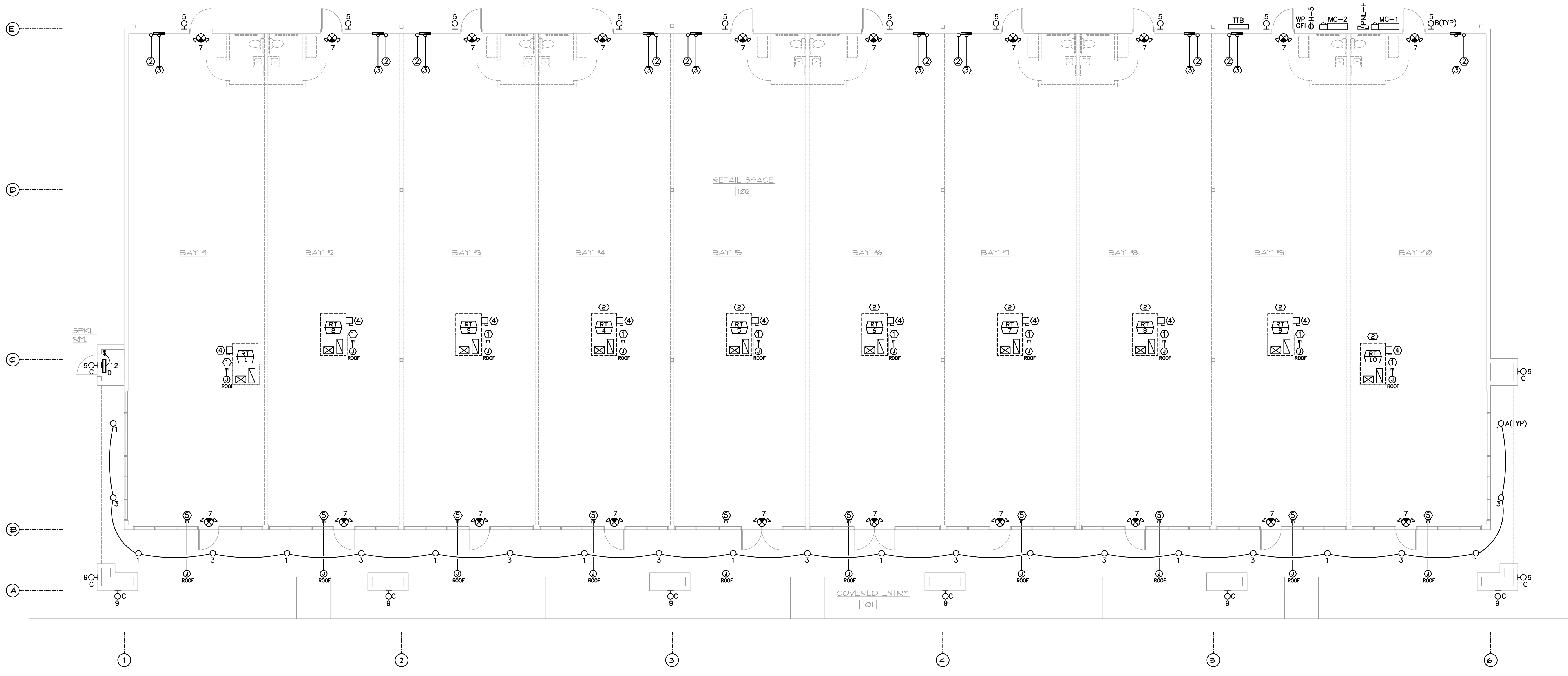

**FLOOR PLAN - ELECTRICAL**

SCALE: 1/8" = 1'-0"

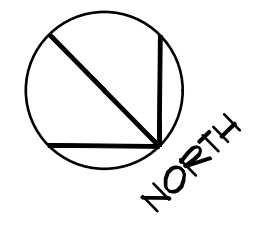

REVISIONS
1
2
3
4
5
6
7
8

PROJECT NO. 17358903-01	DATE 06/07/2015
----------------------------	--------------------

FLOOR PLAN - ELECTRICAL

NEW RETAIL CENTER FOR:  
**KADMAR PLAZA**  
ORLANDO, FLORIDA

**RABITS & ROMANO**  
ARCHITECTURE  
PLANNING AND DESIGN  
5127 SOUTH ORANGE AVE.  
SUITE 110 ORLANDO, FL 32809  
TEL - 407-490-0350  
FAX - 407-232-6000  
info@rabits-architect.com  
www.rabits-architect.com

SIGN/SEAL  
DATE

SHEET  
**E-1**  
OF

**STOFFER & ASSOCIATES, INC.**  
CONSULTING ENGINEERS CA #26069  
10381 Hart Branch Circle Orlando, Florida 32832  
Randall D. Stoffer, P.E. PE #37367  
Phone (407) 381-4555 Fax (407) 249-1520  
ELECTRICAL - HVAC - PLUMBING

**ELECTRICAL SPECIFICATIONS**

- Drawings are diagrammatic and shall not be scaled. Refer to architectural plans and elevations for exact location of all equipment. Electrical contractor shall furnish and install all items required for a complete and acceptable working installation.
- All work shall comply with the 2014 National Electrical Code and shall comply with all local rules and ordinances having jurisdiction.
- Minimum wire size shall be #12 awg. Unless otherwise noted all conductors shall be copper with THWN or THHN insulation.
- All material shall be new and bear the Underwrites Label (U.L.) where applicable.
- The electrical system shall be completely and effectively grounded as required in Article 250 of the National Electrical Code.
- The electrical, telephone, and cable television installations shall meet all requirements by the local utility companies.
- All disconnect switches shall be rated for 100,000 A.I.C. unless otherwise noted. All fuses shall be rated for 200,000 A.I.C. and shall be current limiting.
- All electrical switchgear shall be by Square D, GE, or Siemens. Substitutes must be approved by the engineer.
- Outlet boxes shall be pressed steel in dry locations. Plastic boxes may be used in lieu of the steel box where permitted by local codes. In damp or wet locations boxes shall be made from cast alloy with threaded hubs. Special enclosures are required for other classified areas.
- Separate wire and conduit system may be substituted with factory fabricated assembly of insulated conductors in a flexible metallic enclosure where permitted by local codes.
- Motor starters shall be manual or magnetic with overload relays in each hot leg. It shall be the electrical contractor to provide all starters where required.
- Furnish and install disconnect switches, over current protection, and wiring for the air conditioning system as per manufacturer recommendations. Controls are to be supplied by the air conditioning contractor and connected by the electrical contractor.
- All work shall be performed by a licensed electrical contractor in a first class workmanlike manner. The complete system shall be fully operative and accepted by the engineer or architect.
- All work shall be coordinated with other trades to avoid interference with the progress of construction.
- The electrical contractor shall guarantee all materials and workmanship free from defects for a period of not less than (1) one year from the date of acceptance. Correction of any defects shall be completed without additional charge and shall include replacement or repair of any other phase of the installation which may have been damaged thereby.
- All required insurance shall be provided for protection against public liability or property damage for the duration of the work.

**ELECTRICAL SYMBOLS**

- LED LIGHTING FIXTURE - RECESSED
- LED SCENCE LIGHTING FIXTURE - WALL MOUNTED
- ▬ LED WALL LIGHTING FIXTURE - SURFACE
- ⚡ SINGLE POLE TOGGLE SWITCH - MOUNTED 42" AFF TO CENTERLINE UNLESS OTHERWISE NOTED  
(2) 2 POLE HP RATED TYPE  
(3) 3 WAY  
(4) 4 WAY
- ⊕ DUPLEX RECEPTACLE - MOUNTED 18" AFF TO BOTTOM UNLESS NOTED OTHERWISE  
(GF) GROUND FAULT INTERRUPTING  
(REF) REFRIGERATOR  
(WP) WEATHERPROOF  
(IG) ISOLATED GROUND
- ▶ TELEPHONE/FAX OUTLET - MOUNTED AS REQUIRED
- DISCONNECT SWITCH
- ⊙ JUNCTION BOX
- ▬ ELECTRICAL PANEL
- M METER
- ⚡ EMERGENCY BATTERY LIGHT & EXIT SIGN UNIT - CEILING MOUNTED
- ⚡ EMERGENCY BATTERY UNIT LIGHTING FIXTURE - WALL MOUNTED
- ① SEE NOTE SYMBOL
- SOLID LINE INDICATES EQUIPMENT ON COMMON CIRCUIT AND/OR CONTROLLED BY COMMON SWITCH. EACH CIRCUIT SHALL CONSIST OF A PHASE CONDUCTOR, NEUTRAL AND GROUND CONDUCTOR. ELECTRICAL CONTRACTOR SHALL PROVIDE ALL NECESSARY SWITCH LEGS IN CONDUIT TO ACHIEVE SWITCHING INDICATED ON PLANS.

NOTE: NOT ALL SYMBOLS MAY BE USED.

**LIGHTING FIXTURE SCHEDULE**

Mark	Lamp		Fixture Description	Fixture Data		Mount	Voltage	See Note
	No.	Type		Manufacturer	Catalog Number			
A	1	21W LED	RECESSED LED DOWNLIGHT	PATHWAY	65FK-65FL2X-20-4K-120-DD-WL2-SCLPF	REC	120	
B	1	18W LED	EXTERIOR WALL LIGHT	LITHONIA	TWS-LED-P1-50K-MVOLT-DOB-M4	WALL	120	
C	1	14W LED	EXTERIOR WALL LIGHT	LITHONIA	OLLWU-LED-P1-40K-MVOLT-DOB	WALL	120	
D	1	25.83W LED	4' WALL LIGHT	LITHONIA	CLX-LED-L24-3500LM-SEF-FDL-MVOLT-			1,3
EM		INCL	EMERGENCY LIGHT	LITHONIA	ELM2 SERIES	WALL	120	1,2,3
X1		INCL	COMBO EXIT SIGN/EMERGENCY LIGHT	LITHONIA	LHQM-S-W-3-R	WALL	120	1,3

- GENERAL LIGHTING FIXTURE NOTES:**
- CONTRACTOR SHALL COORDINATE FIXTURE MOUNTING WITH ARCHITECTURAL REFLECTED CEILING PLAN(S) AND SHALL PROVIDE FIXTURE MOUNTING AS REQUIRED TO MATCH CEILING TYPE.
  - ALL ELECTRICAL FIXTURES MUST BE INDEPENDENTLY SUPPORTED OF CEILING GRID. LIGHT FIXTURES WEIGHING LESS THAN 10 POUNDS SHALL HAVE AT LEAST ONE 12 GAGE HANGER WIRE CONNECTED FROM THE FIXTURE TO THE STRUCTURE ABOVE. LIGHTS WEIGHING MORE THAN 10 POUNDS SHALL HAVE AT LEAST TWO 12 GAGE WIRES ATTACHED AT OPPOSING CORNERS OF THE LIGHT FIXTURE.

- LIGHTING FIXTURE SCHEDULE NOTES:**
- FIXTURES SHALL BE PROVIDED WITH INTEGRAL EMERGENCY BATTERY BACK-UP.
  - FIXTURE SHALL BE WALL MOUNTED AT 7'-6" AFF.
  - FIXTURES TO BE PROVIDED WITH INTEGRAL EMERGENCY BATTERY BACK-UP. FIXTURES SHALL BE CONNECTED TO CONSTANT NORMAL ROOM LIGHTING BRANCH CIRCUIT OF AREA SERVED (1, 2, LOAD SIDE OF BREAKER, LINE SIDE OF ANY SWITCHING/CONTROLLING DEVICES).
  - FIXTURES TO BE PROVIDED WITH INTEGRAL EMERGENCY BATTERY BACK-UP. THE EMERGENCY BALLAST SHALL BE CONNECTED TO CONSTANT NORMAL ROOM LIGHTING BRANCH CIRCUIT OF AREA SERVED (1, 2, LOAD SIDE OF BREAKER, LINE SIDE OF ANY SWITCHING/CONTROLLING DEVICES). THE LIGHT FIXTURE IS TO BE COMPLETELY SWITCHED AND THE EMERGENCY BALLAST OPERATES ONLY IN THE EVENT OF A BRANCH CIRCUIT POWER FAILURE.

CIRCUIT BREAKER PANEL - "H"									
SERVICE: 120/208V, 3PH, 4W					BUSSES: 100 AMP MLO NEMA-3R				
A.I.C. RATING: 10,000					SPACES: 24 MTG: SURFACE				
CKT	CB	WIRE	COND	GND	LOAD DESCRIPTION	PHA	PH-B	PH-C	
1	20/1	2#10	1/2"	#10	CANOPY LIGHTING	+	251		
3	20/1	2#10	1/2"	#10	CANOPY LIGHTING	+			
5	20/1	2#12	1/2"	#12	REAR WALL LIGHTING	+			
7	20/1	2#12	1/2"	#12	EXIT/EMERG LGT	+	50		
9	20/1	2#12	1/2"	#12	FRONT COLUMN LGT	+		258	
11	20/1	2#12	1/2"	#12	RECEPTACLE				180
13					SPACE				
15					SPACE				
17					SPACE				
19					SPACE				
21					SPACE				
23					SPACE				
2	20/1	2#12	1/2"	#12	TELEPHONE RECEPTACLE	+	360		
4	20/2	2#10	3/4"	#10	SITE LIGHTING	+		178	178
6	---	---	---	---	---				
8	20/2	2#10	3/4"	#10	SITE LIGHTING	+	178		178
10	---	---	---	---	---				
12	20/1	2#12	1/2"	#12	FIRE SPRINKLER LIGHT				26
14					SPACE				
16					SPACE				
18					SPACE				
20					SPACE				
22					SPACE				
24					SPACE				
SUB-TOTAL LOAD							839	845	564
SUB-TOTAL AMPS							7	7	5

\* VA PHOTOCELL AND TIMECLOCK  
+ VA PHOTOCELL FOR CONTACTOR

SERVICE LOAD SUMMARY MC-2	
5 BAYS	= 324000 VA
TOTAL LOAD	= 324000 VA = 900 A

SERVICE LOAD SUMMARY MC-1	
5 BAYS	= 324000 VA
PANEL H	= 2295 VA
TOTAL LOAD	= 326295 VA = 908 A

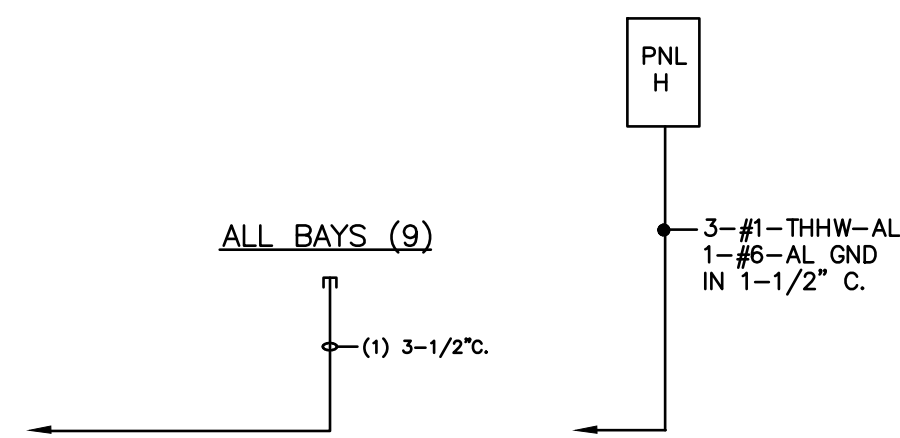
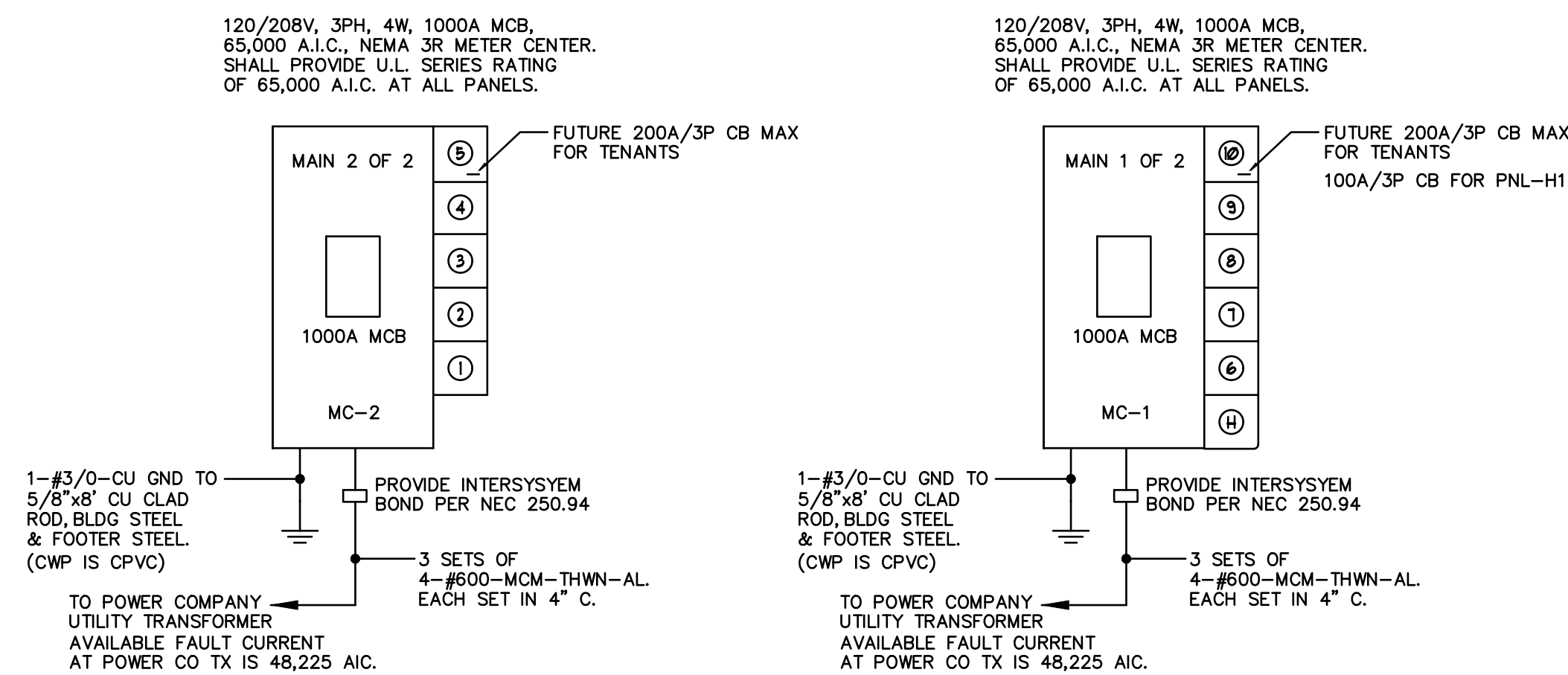

**ELECTRICAL RISER DIAGRAM - 120/208V, 3PH, 4W**  
NTS

**FLOOR PLAN - ELECTRICAL**

SCALE: 1/8" = 1'-0"

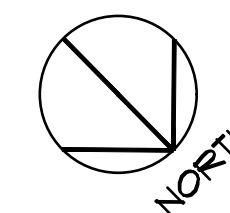

REVISIONS	PROJECT NO.	DATE
1	17580903-01	06/07/2015
2		
3		
4		
5		
6		
7		
8		

DETAILS AND RISER

NEW RETAIL CENTER FOR:  
**KADMAR PLAZA**  
ORLANDO, FLORIDA

RABITS & ROMANO ARCHITECTURE  
PLANNING AND DESIGN  
5127 SOUTH ORANGE AVE., SUITE 110 ORLANDO, FL 32809  
TEL: 407-490-0350  
FAX: 407-232-6000  
info@rabits-architect.com  
www.rabits-architect.com

SIGN/SEAL

DATE

SHEET  
**E-2**  
OF

**STOFFER & ASSOCIATES, INC.**  
CONSULTING ENGINEERS CA #26069  
10381 Hart Branch Circle Orlando, Florida 32832  
Randall D. Stoffer, P.E. PE #37367  
Phone (407) 381-4555 Fax (407) 249-1520  
ELECTRICAL - HVAC - PLUMBING